

LEGO SYSTEM™

MODEL TEAM 5563

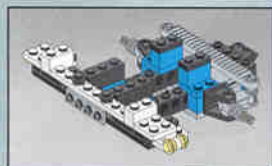

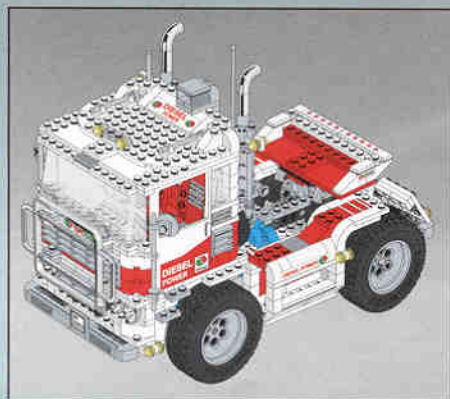
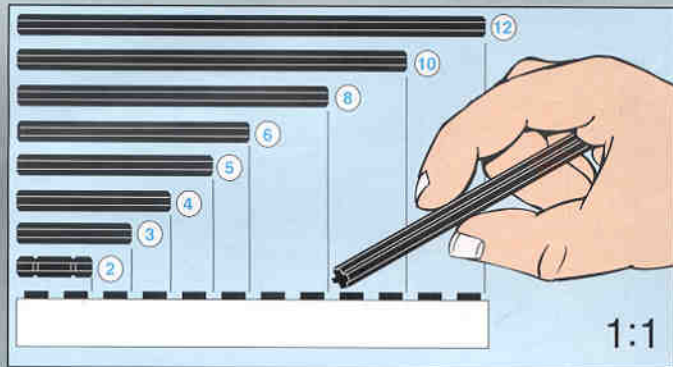

1

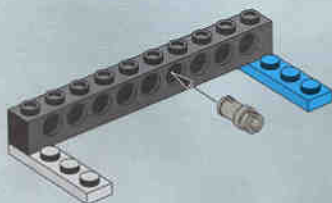



2

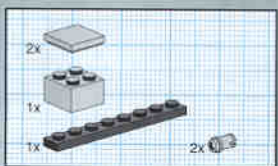
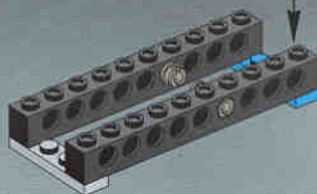
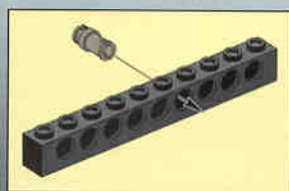

3

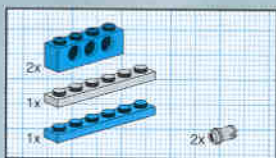
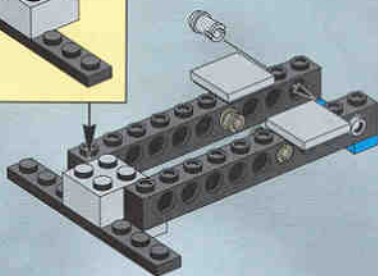
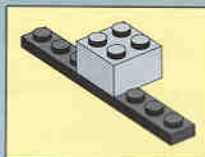

4

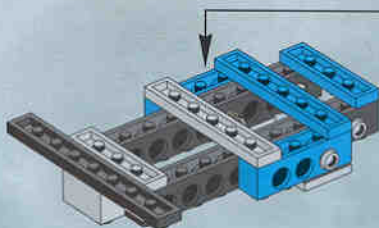
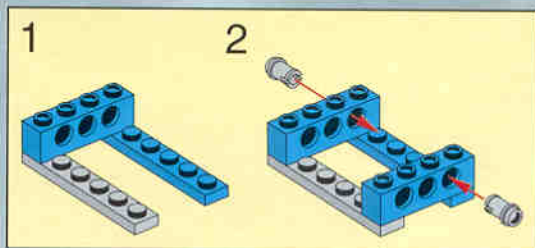



5

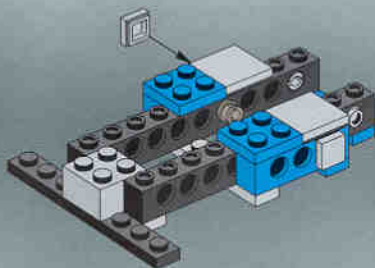

6

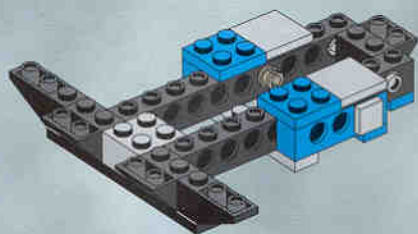

7

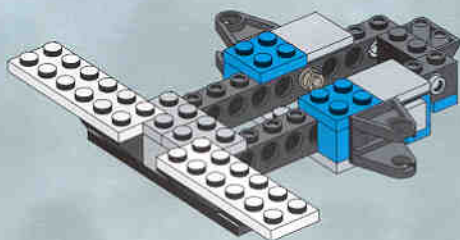

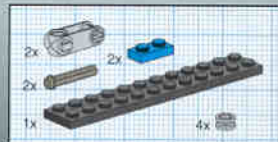

8

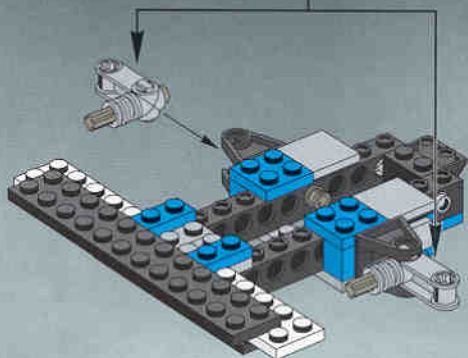
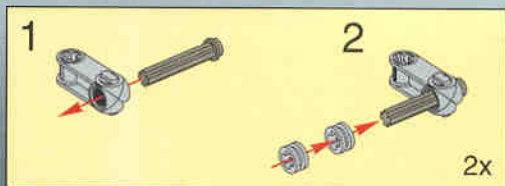

9

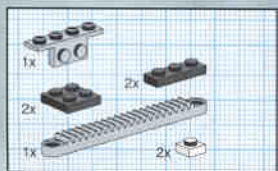
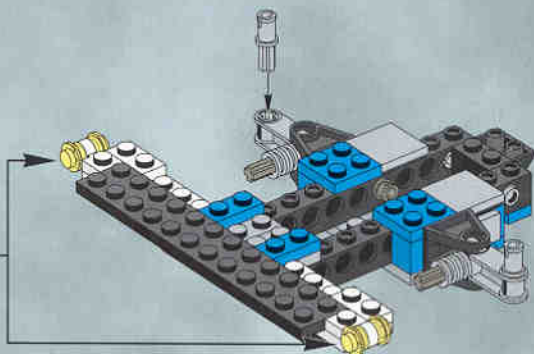
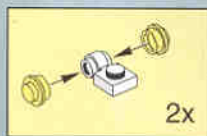

10

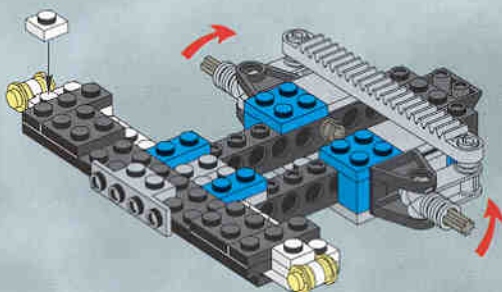

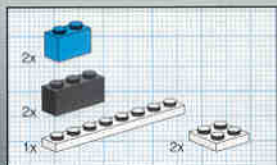

11

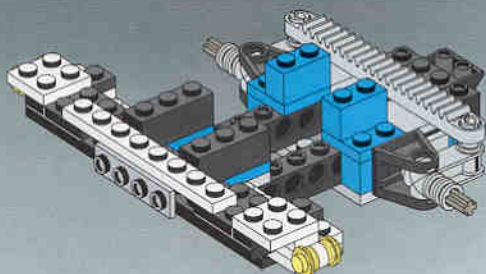

12

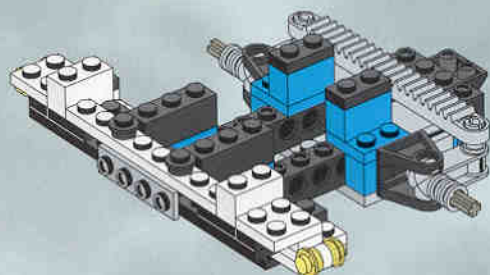

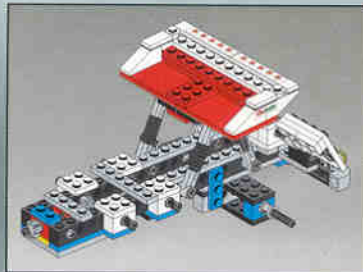

1

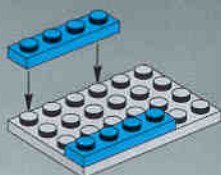

2

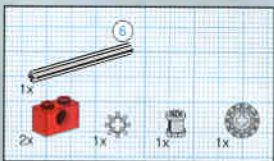
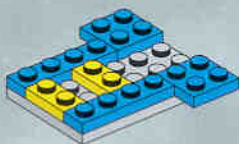

3

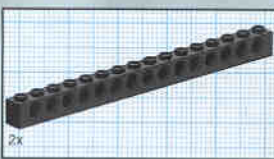

4

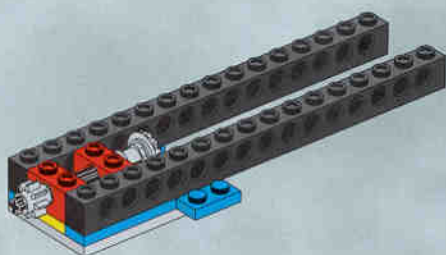



5

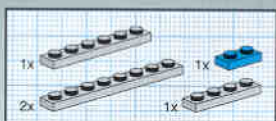
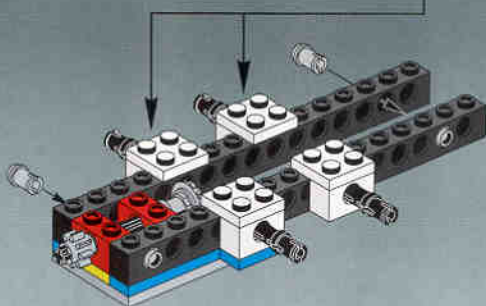

6

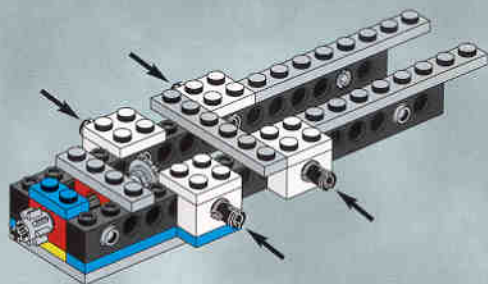

7

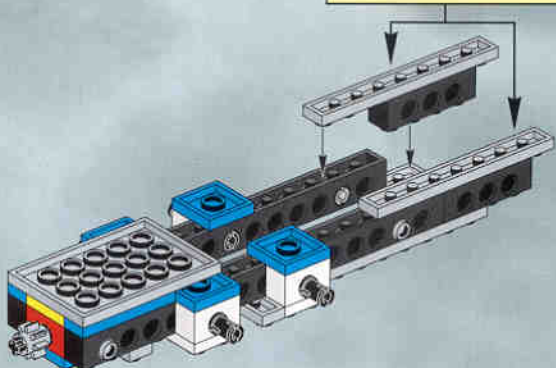
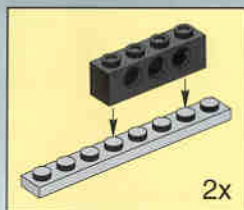

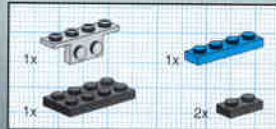

8

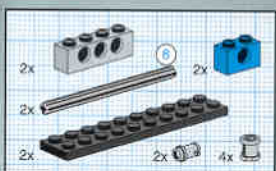
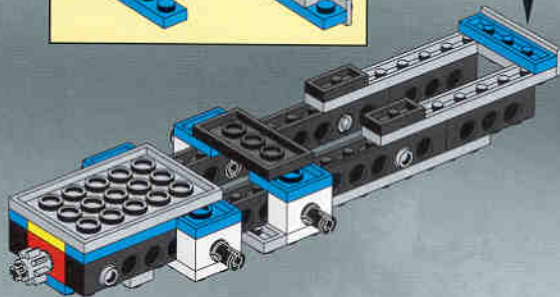
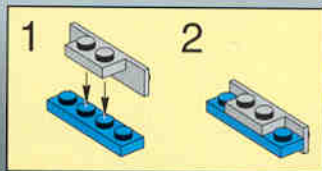

9

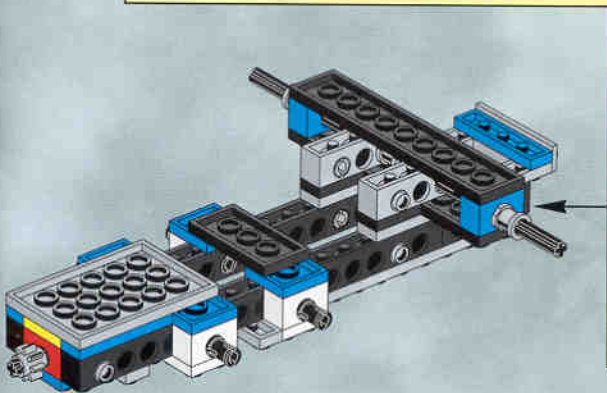
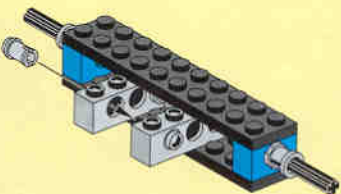
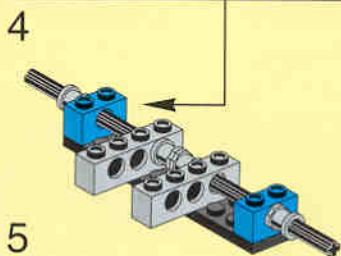
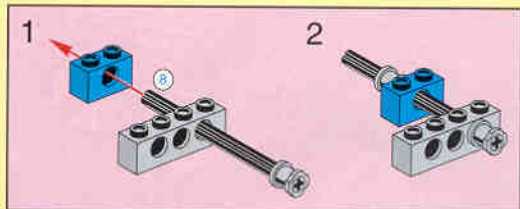
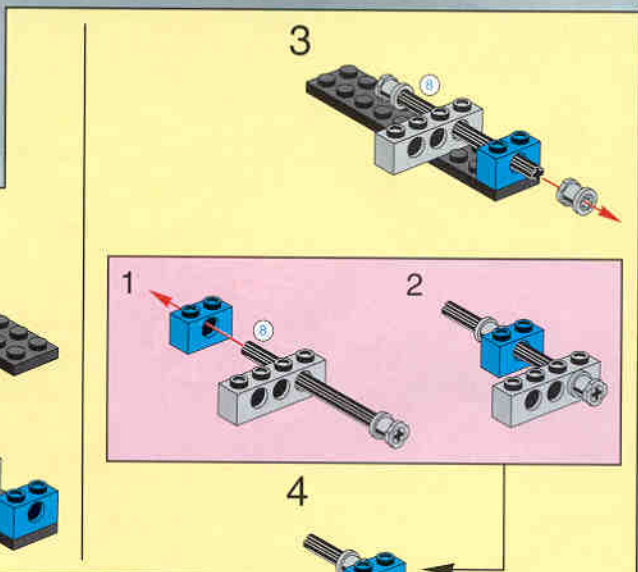
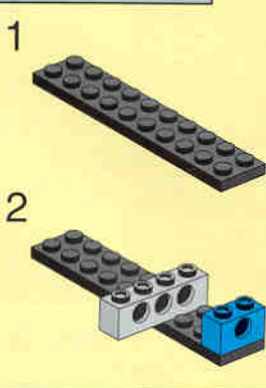

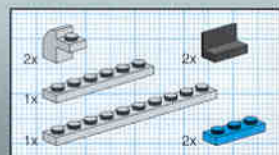

10

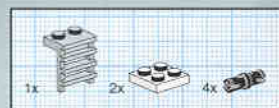
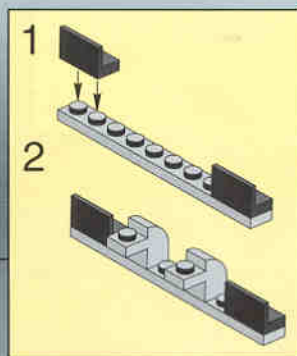
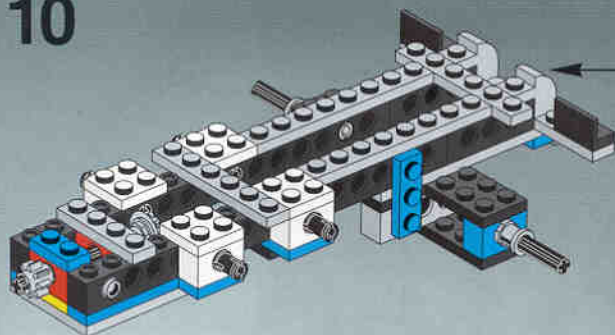

11

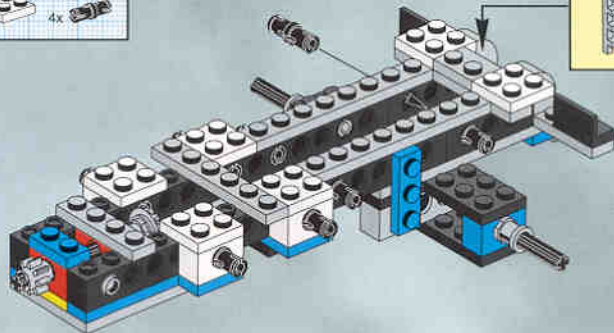

12

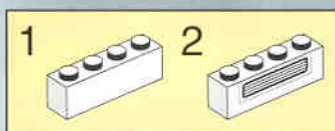
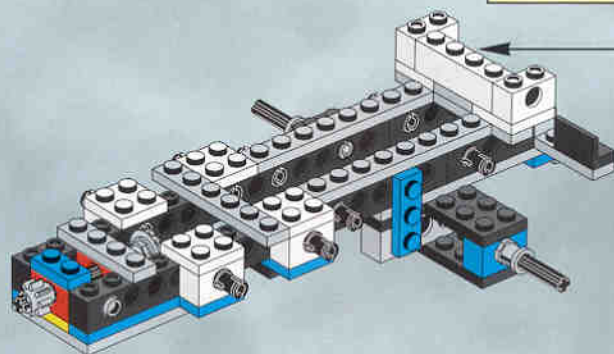

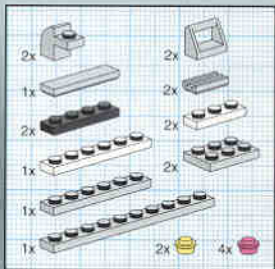

13

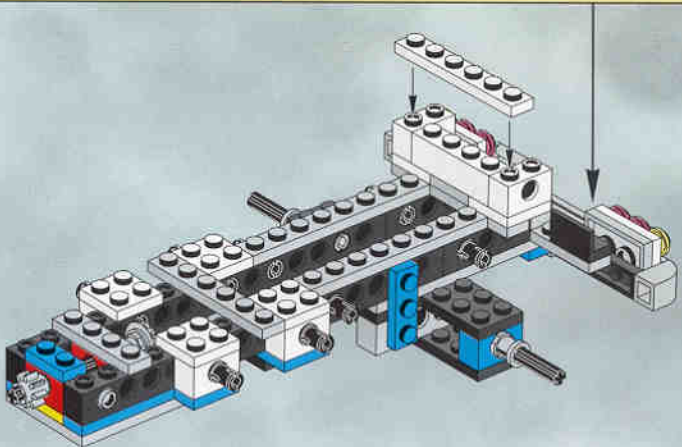
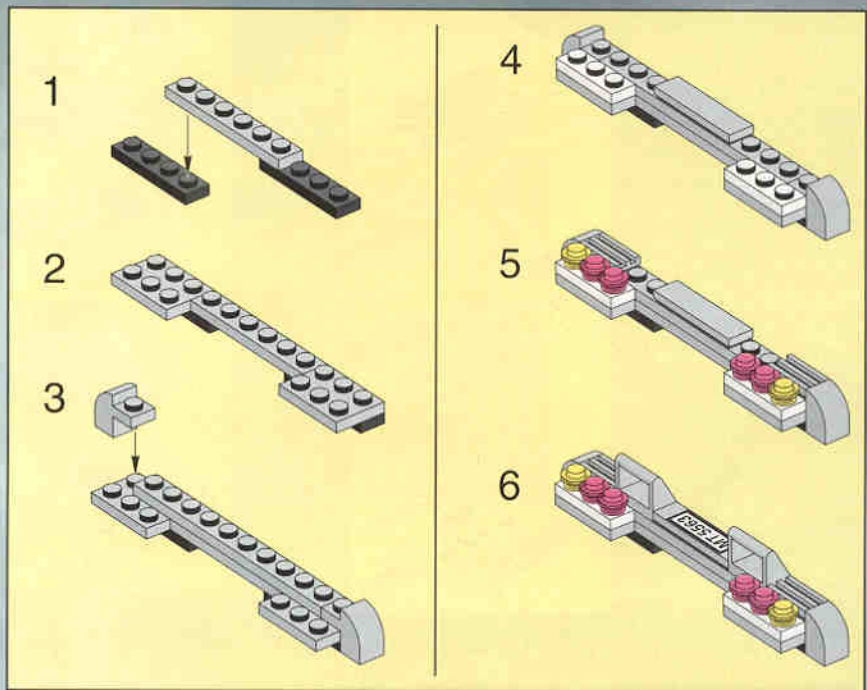

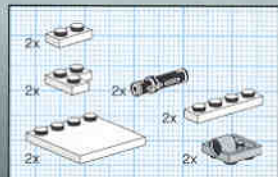

14

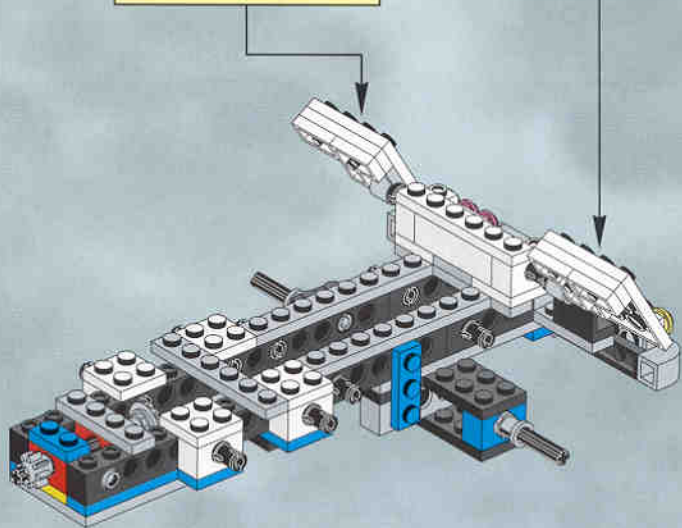
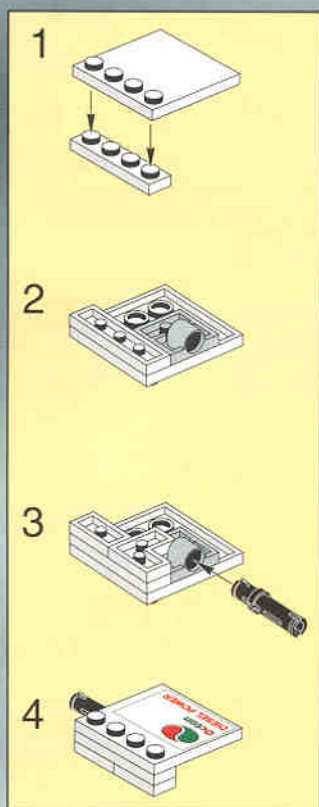
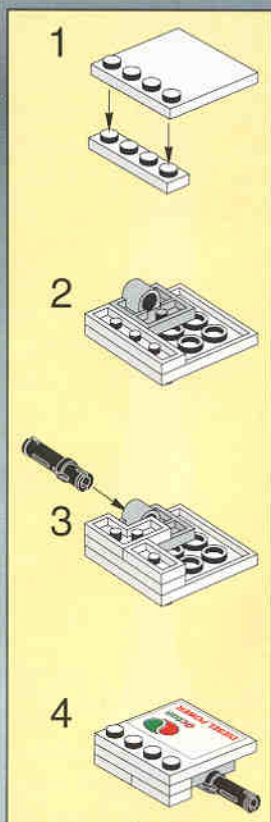



15

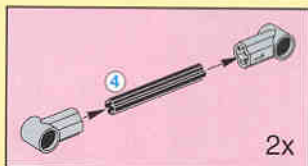
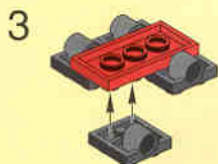

5

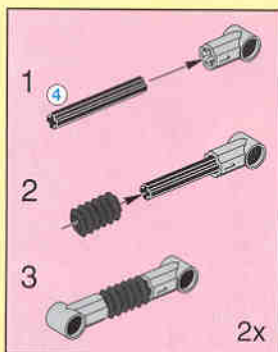
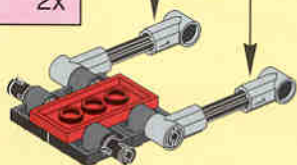

6

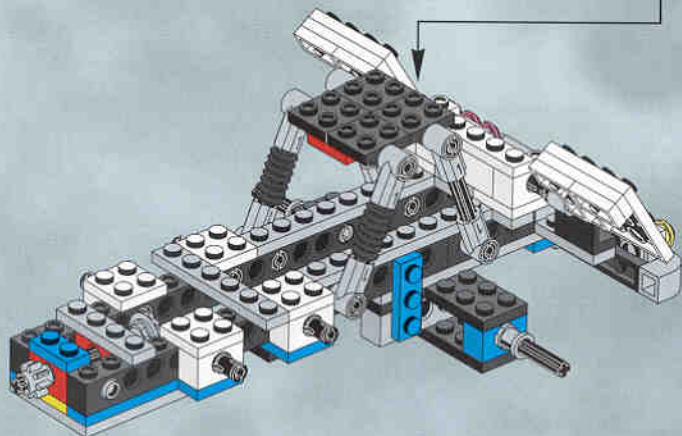
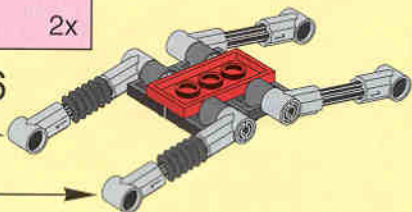

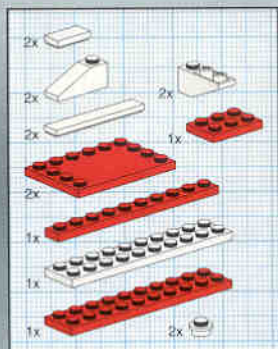

16

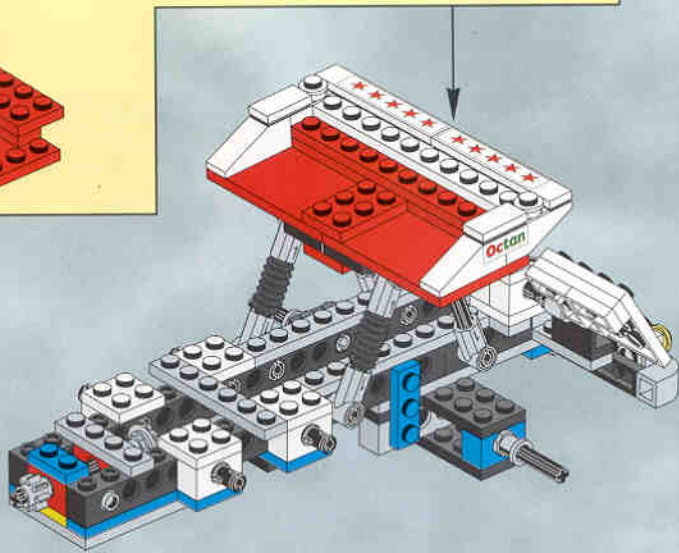
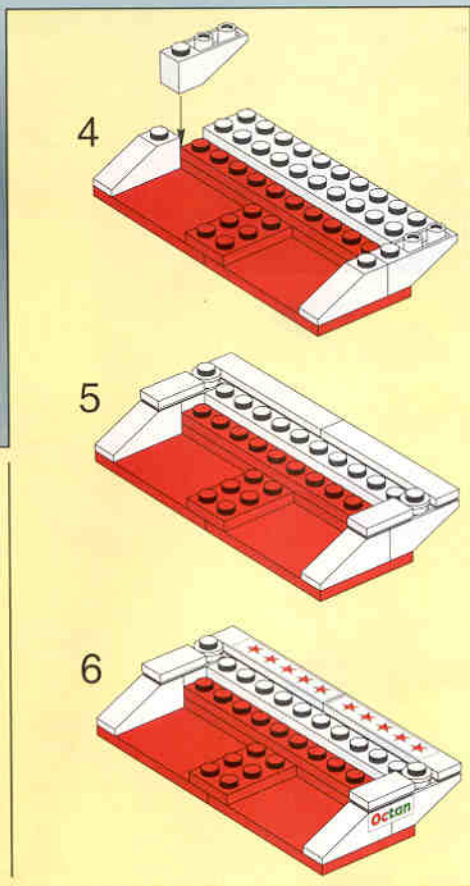
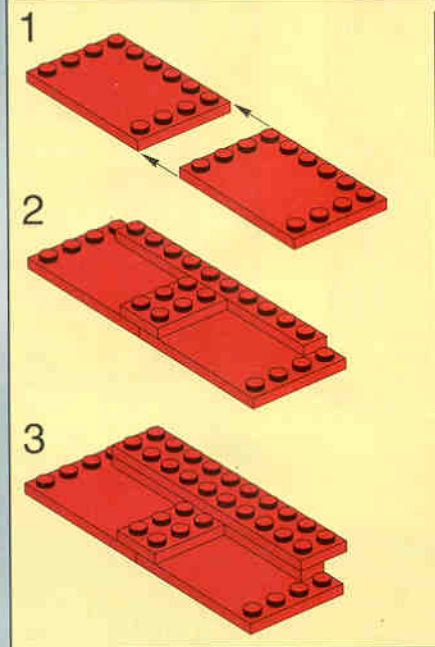

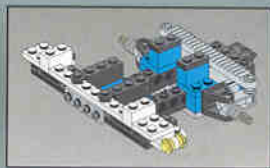

+

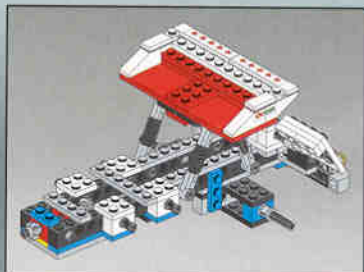

17

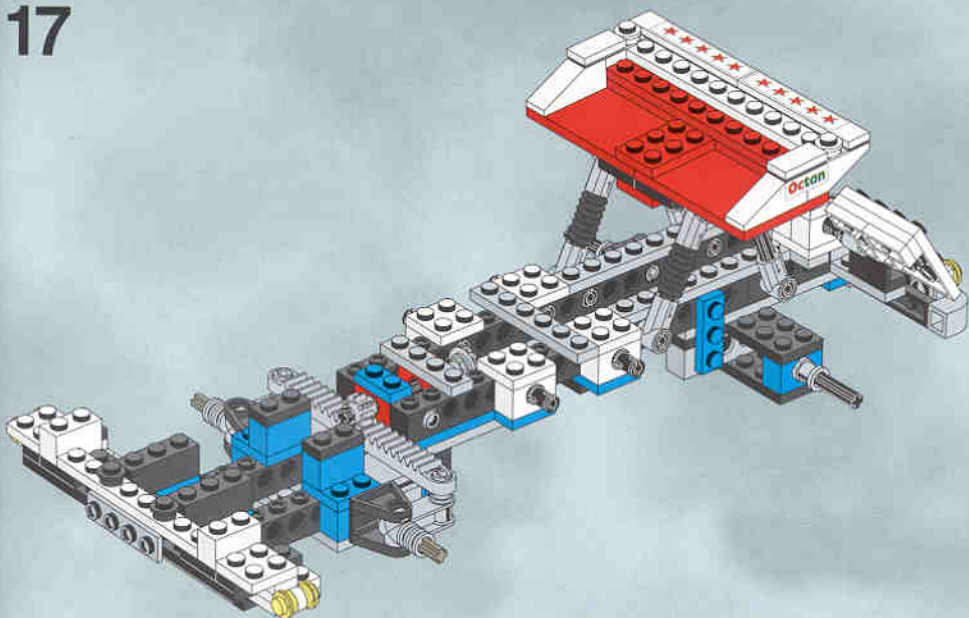

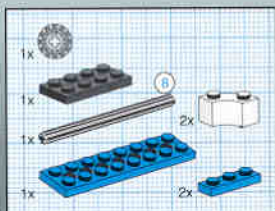

18

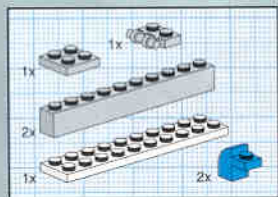
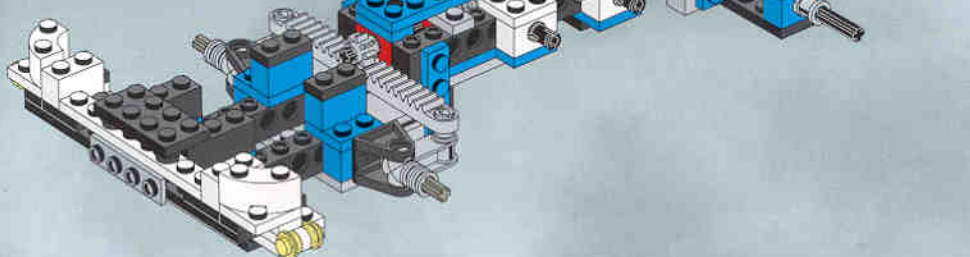
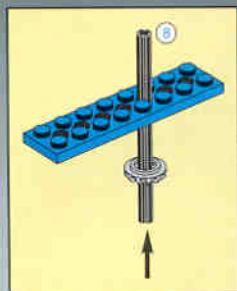

19

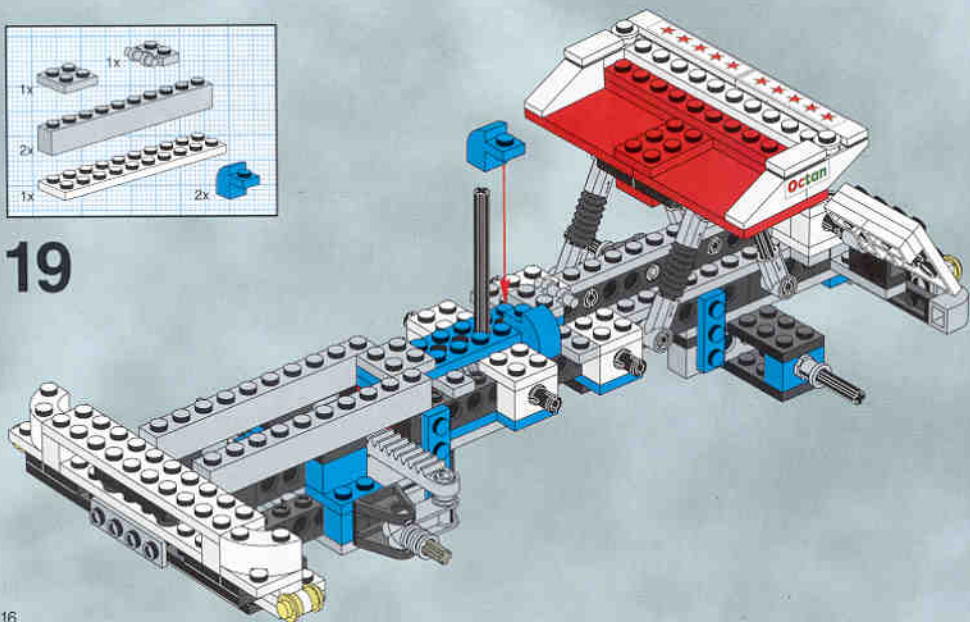

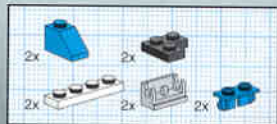

20

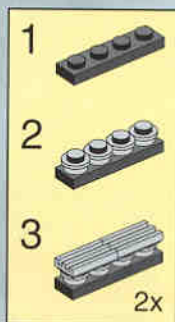
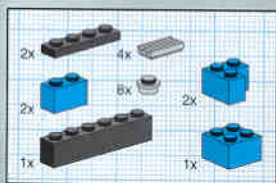
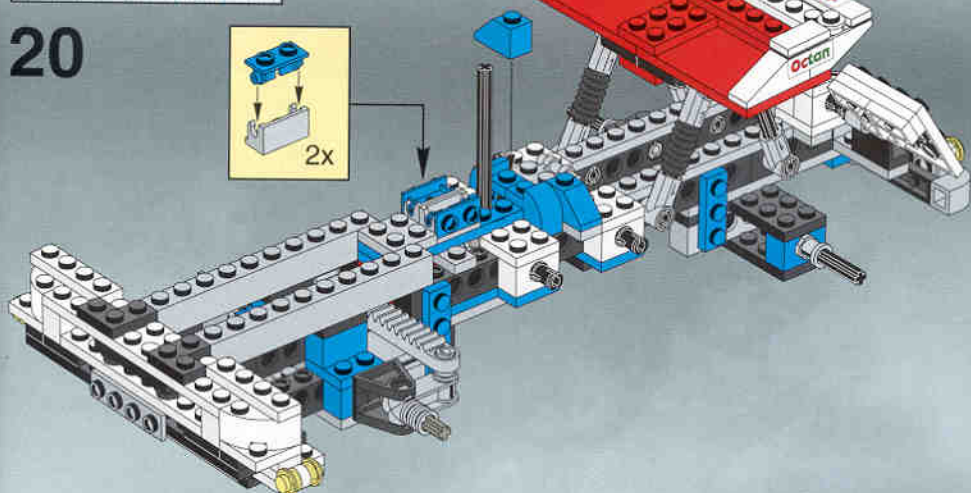

21

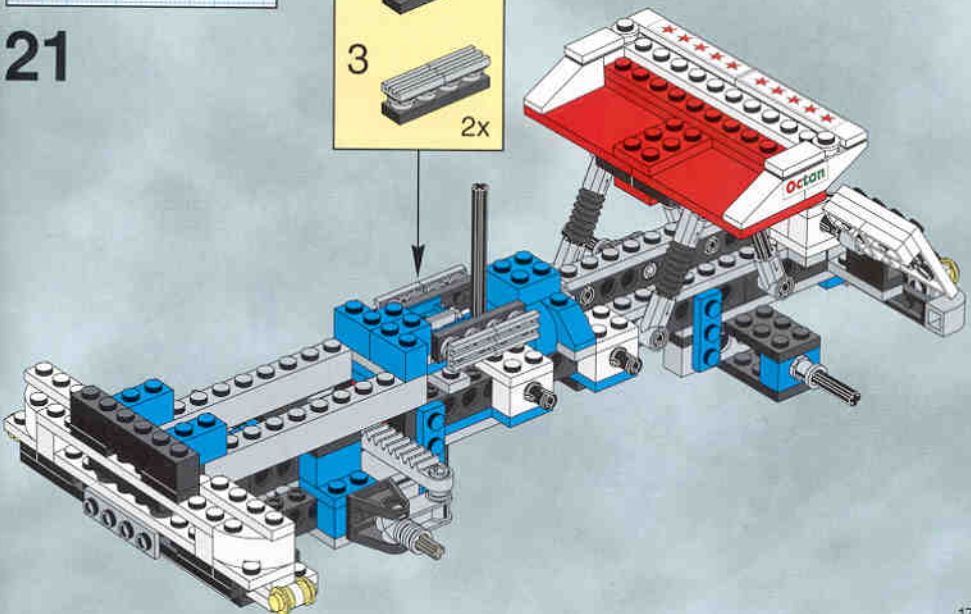



22

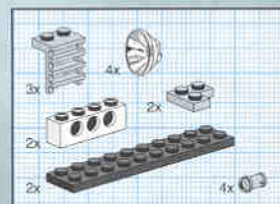
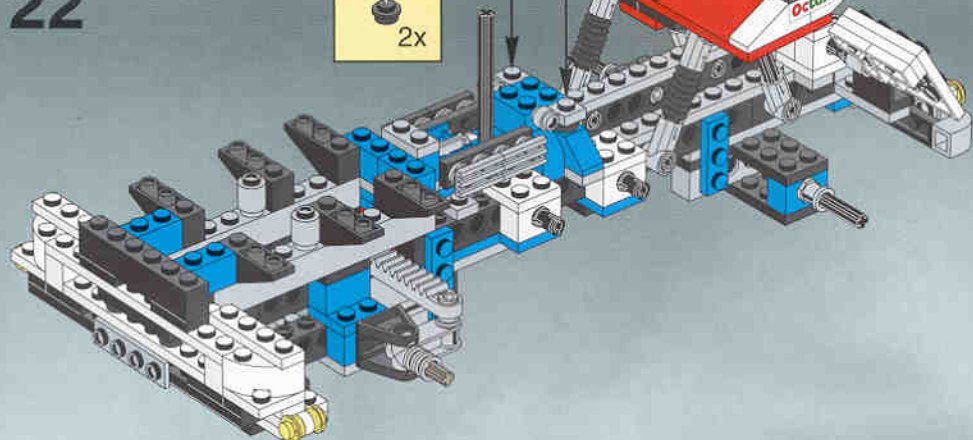

23

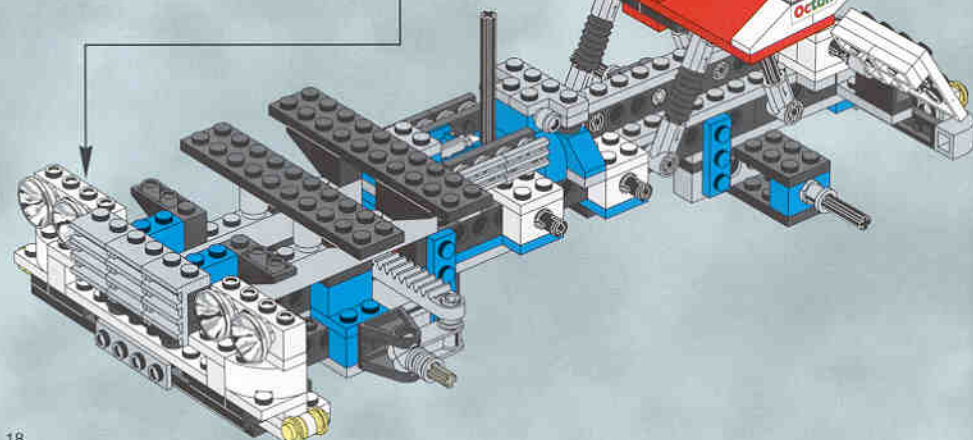
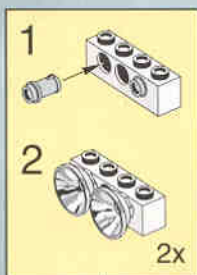

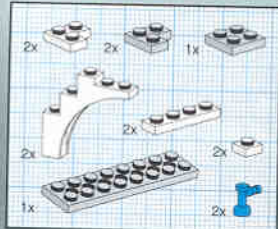

24

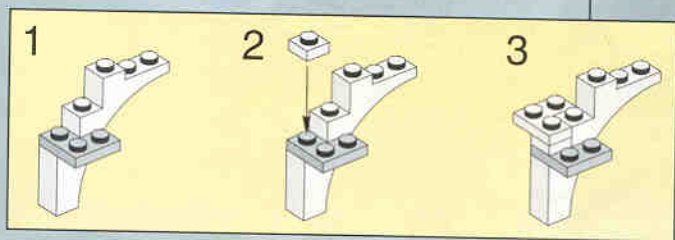
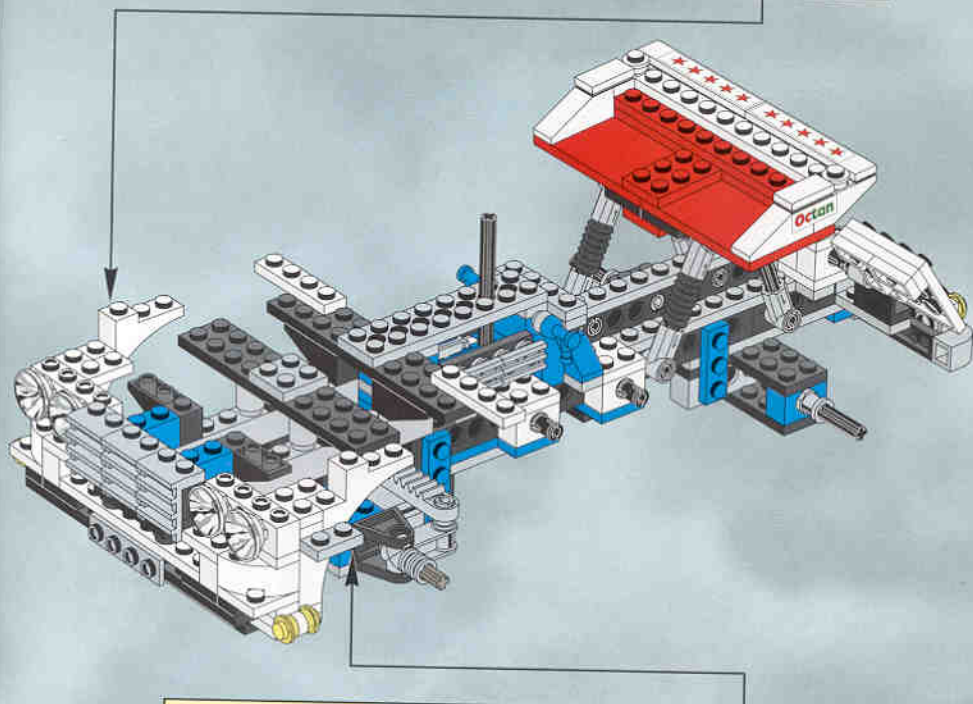
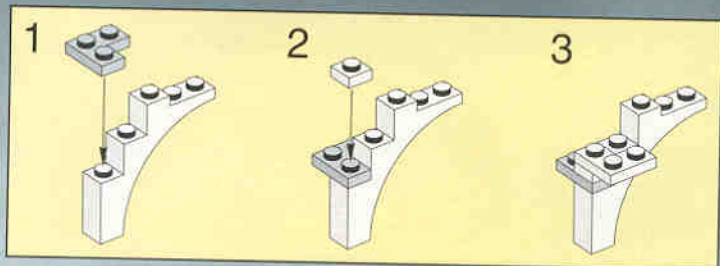

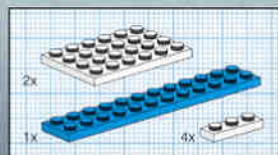

25

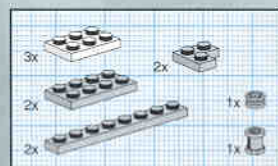
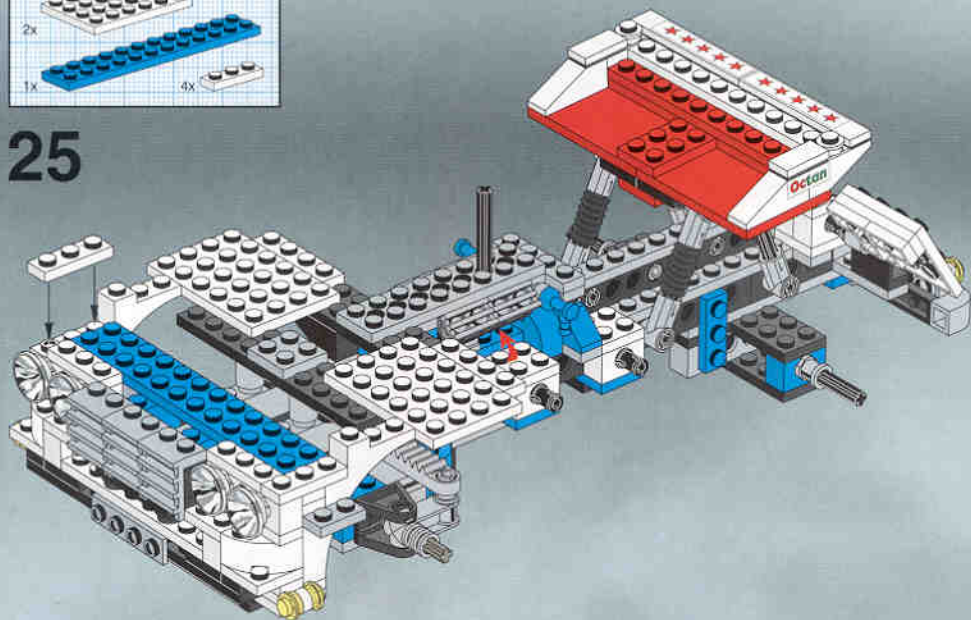

26

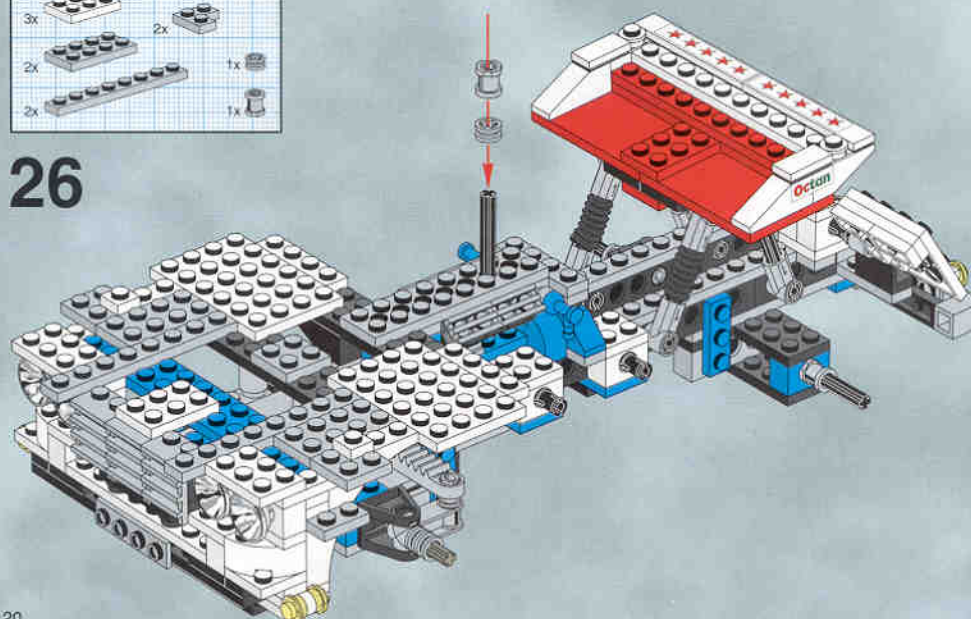

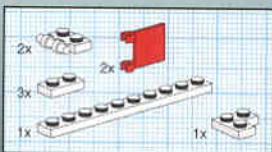

27

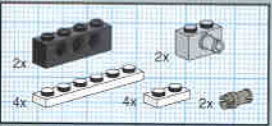
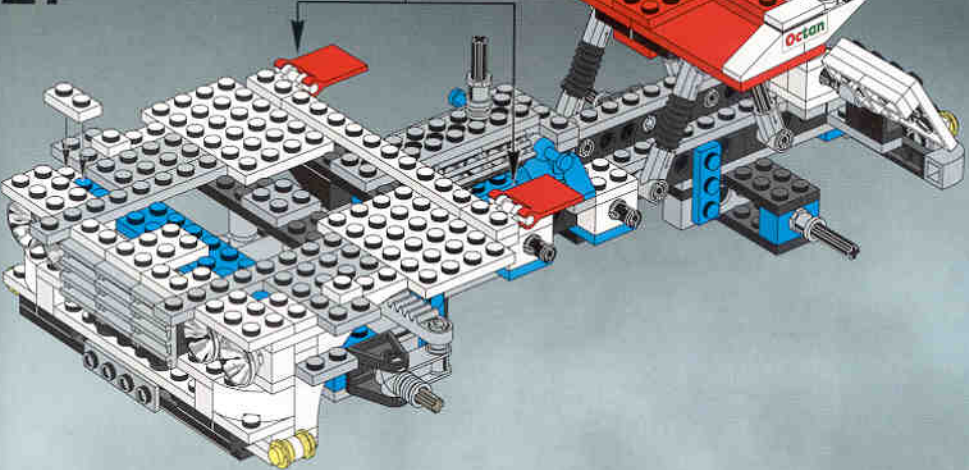

28

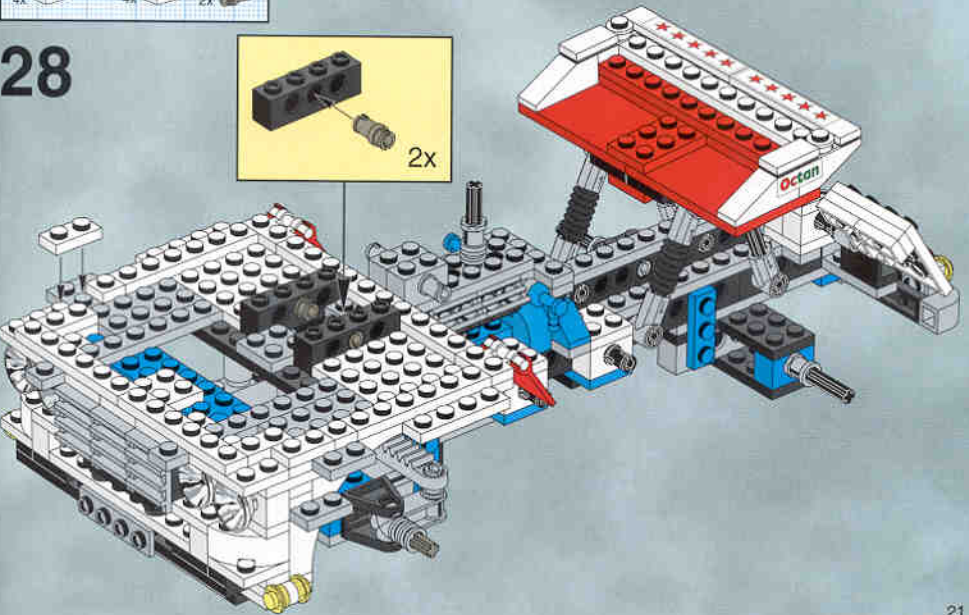

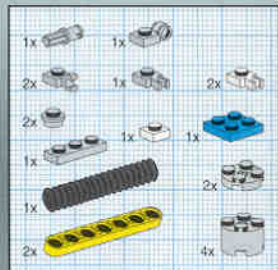

29

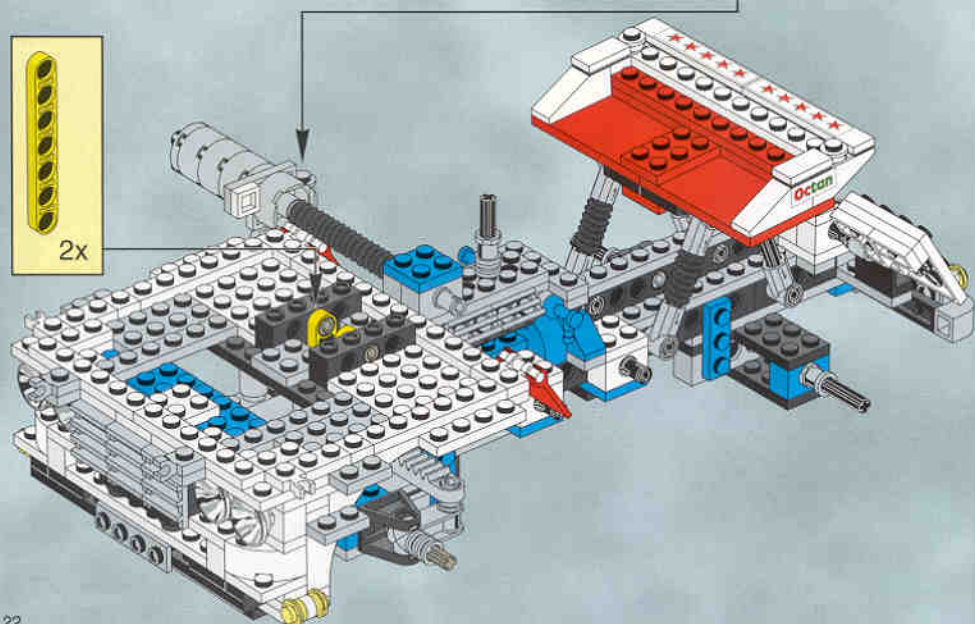
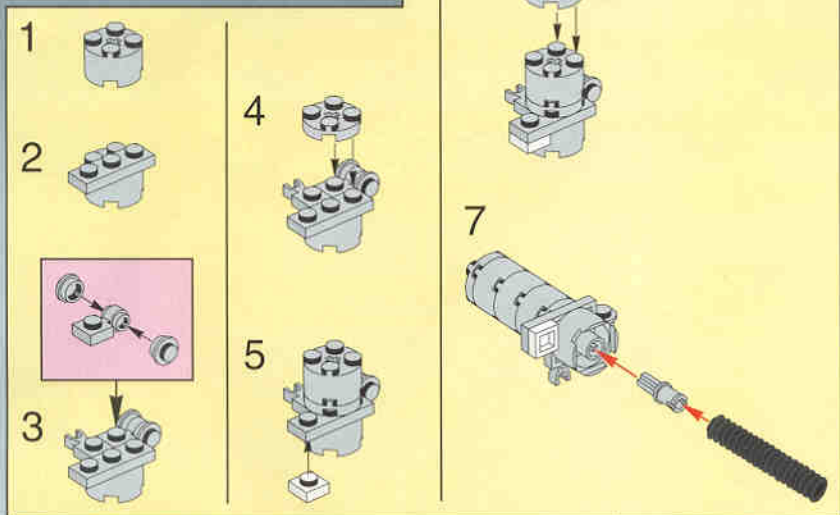

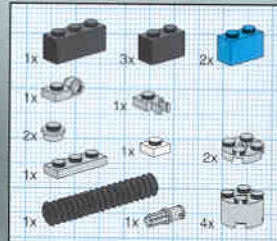

30

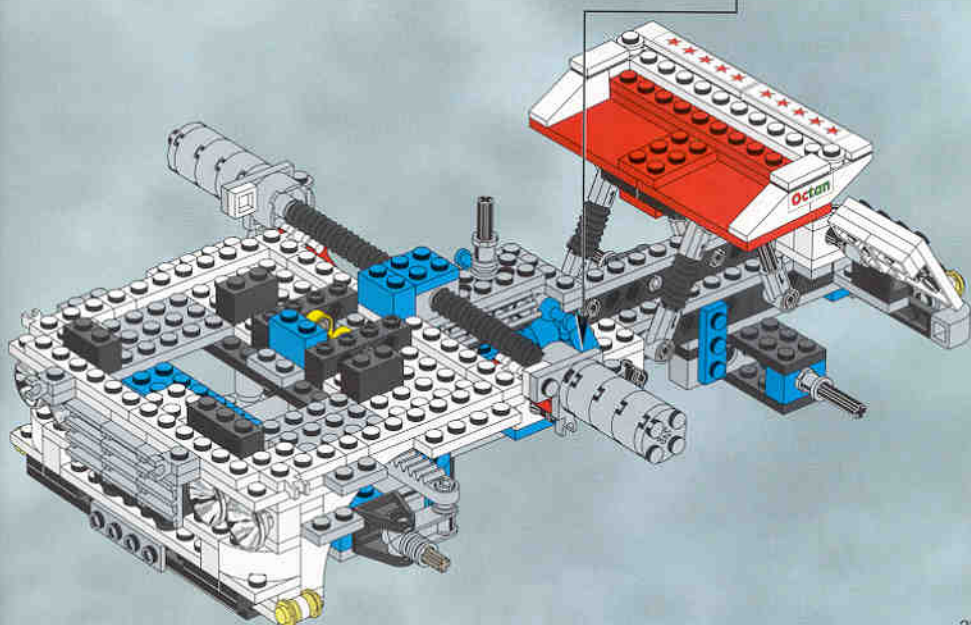
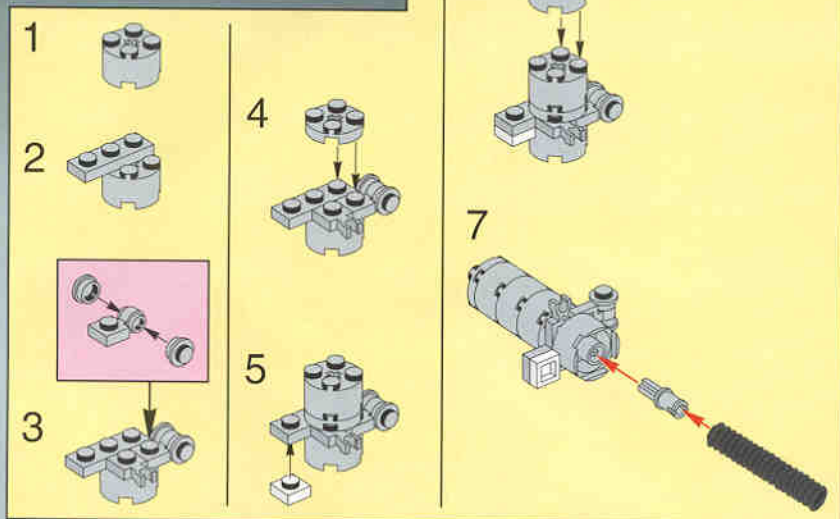

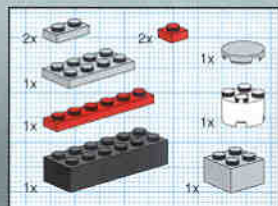

31

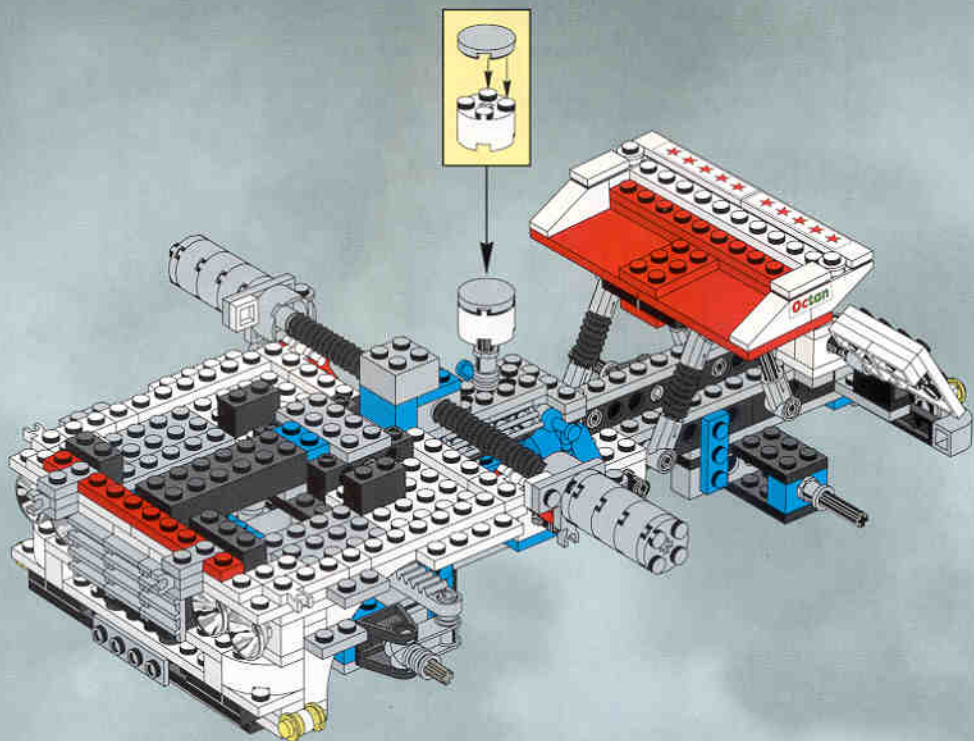

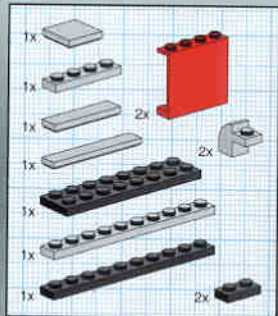

32

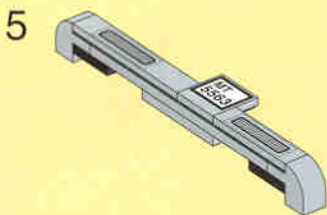
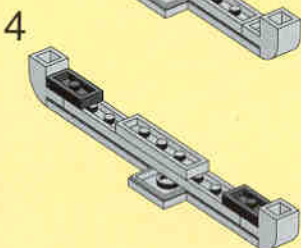
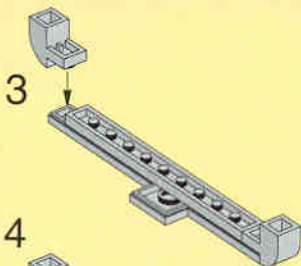
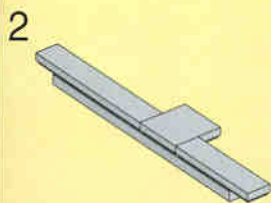
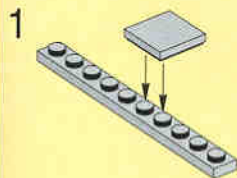
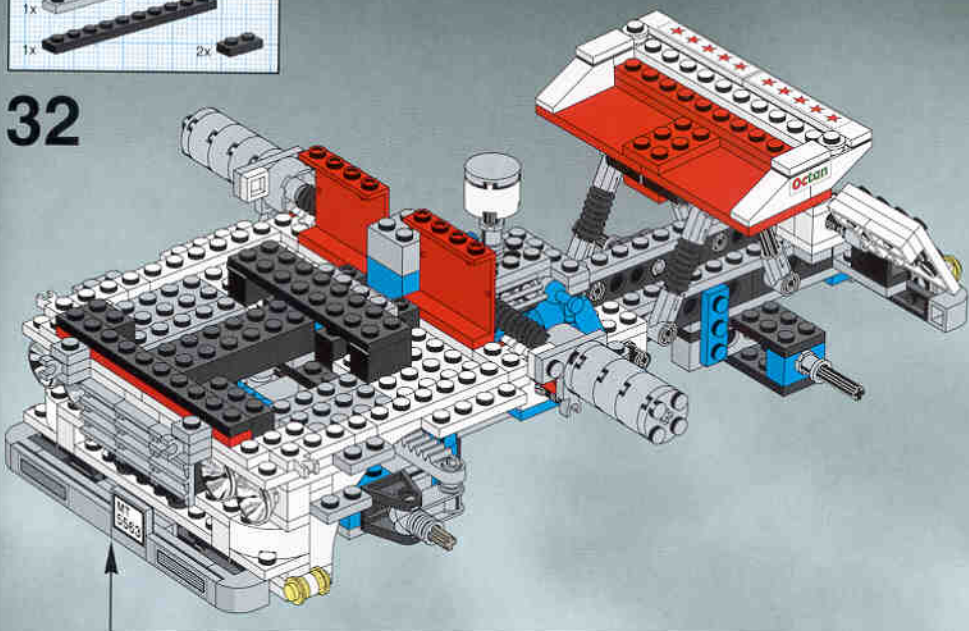

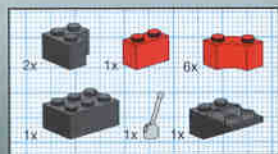

33

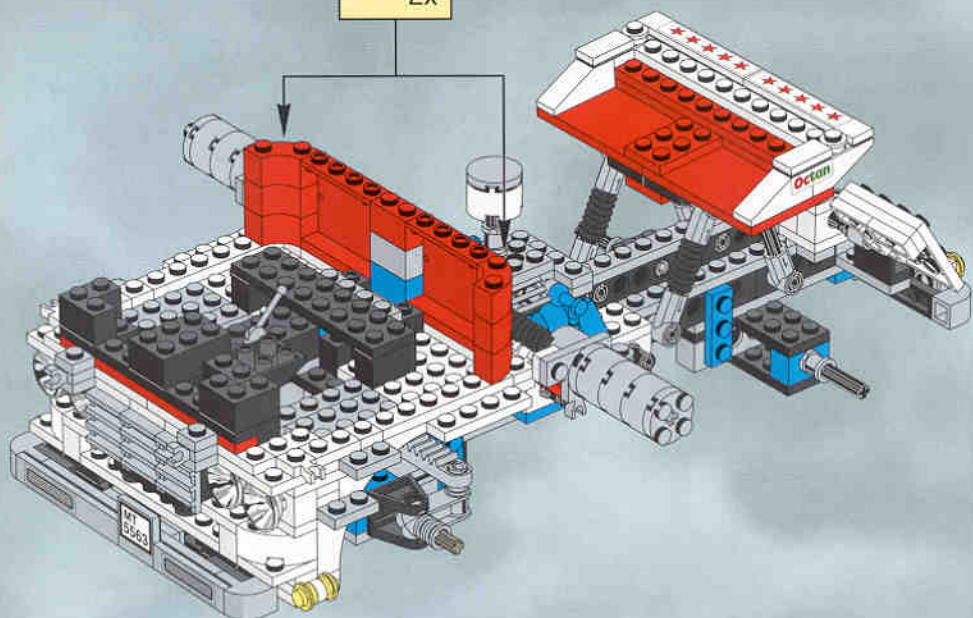
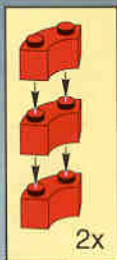

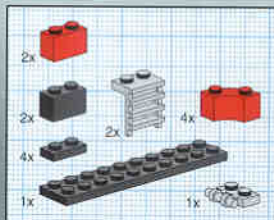

34

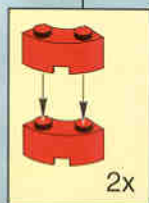
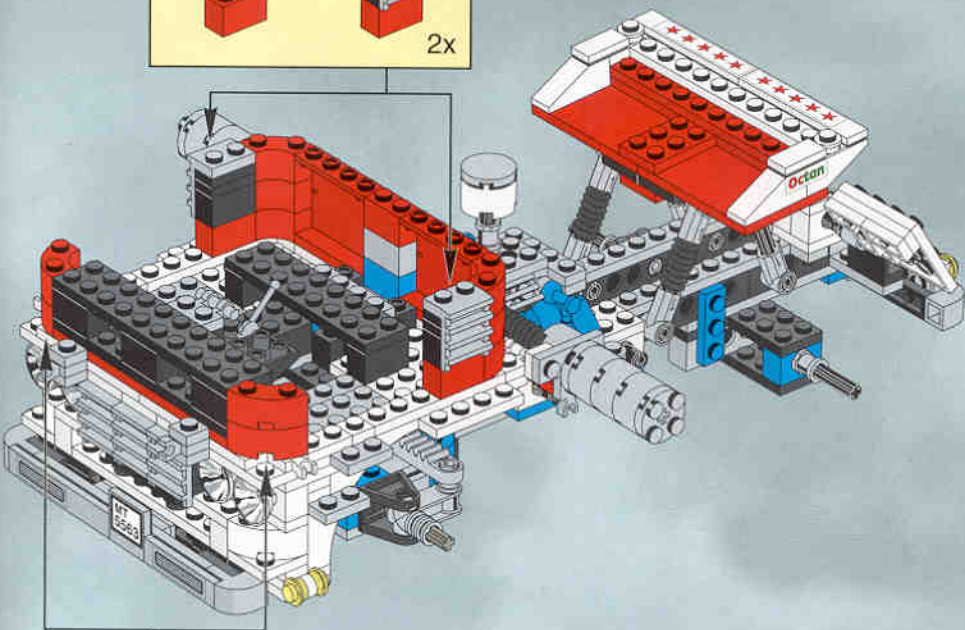
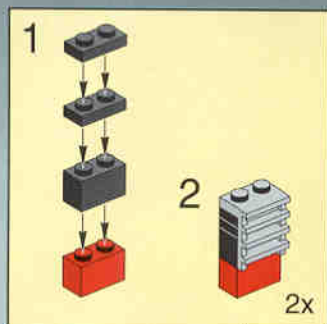

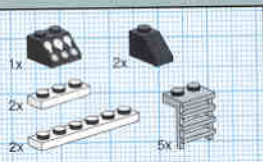

35

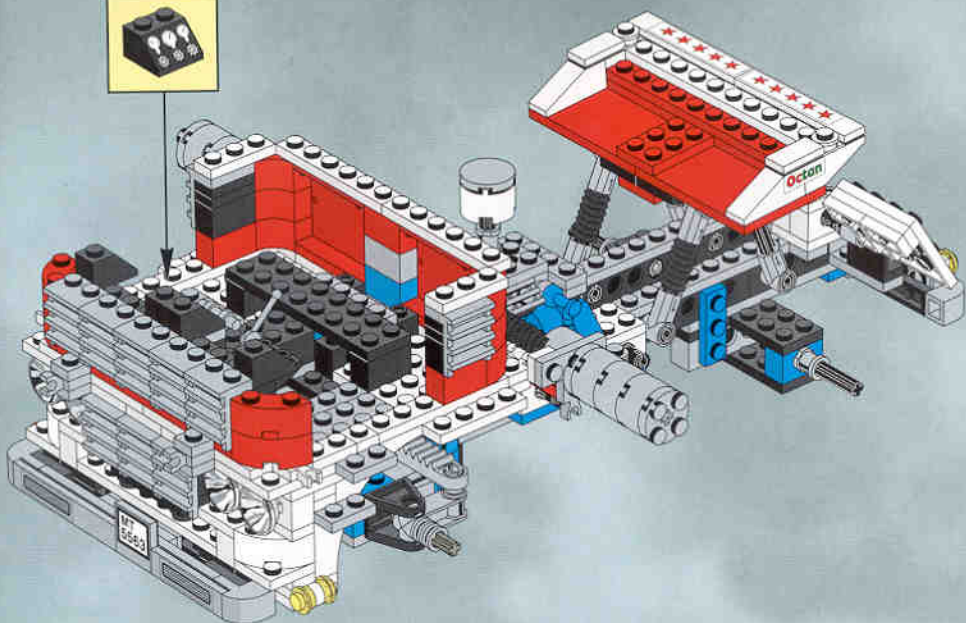



36

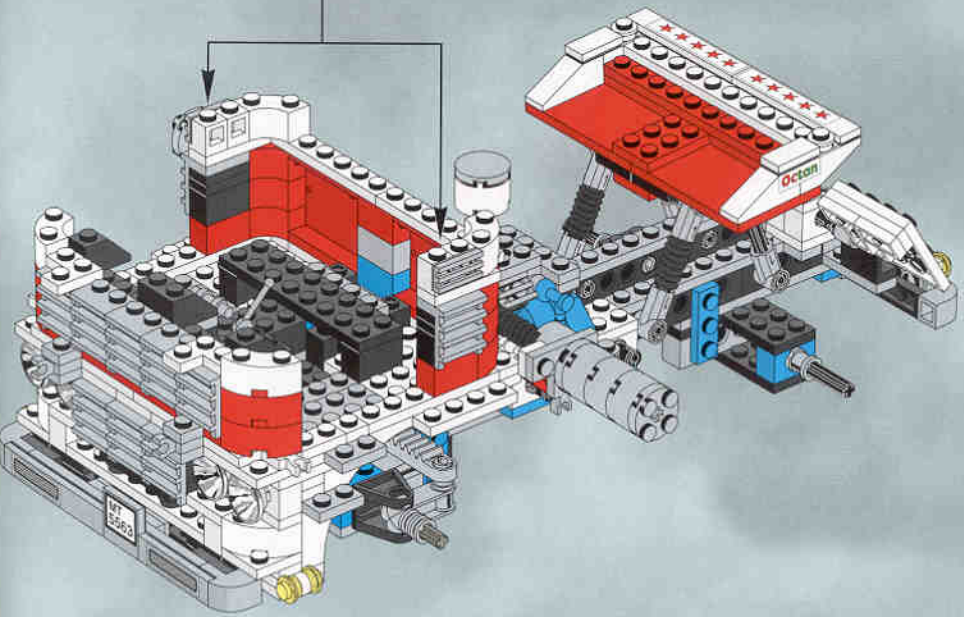
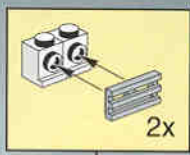

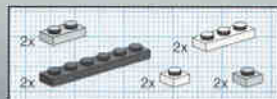

37

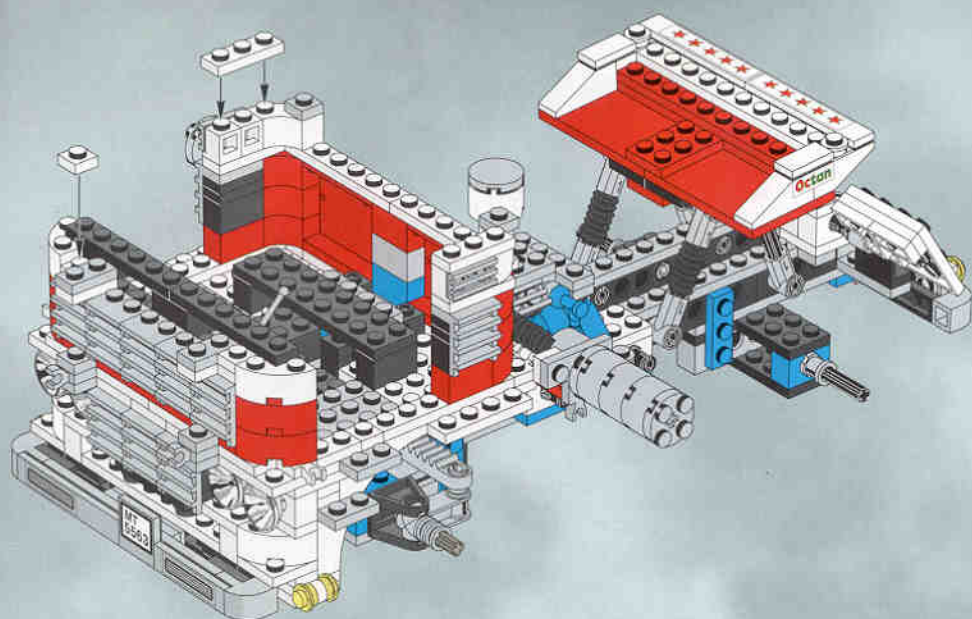

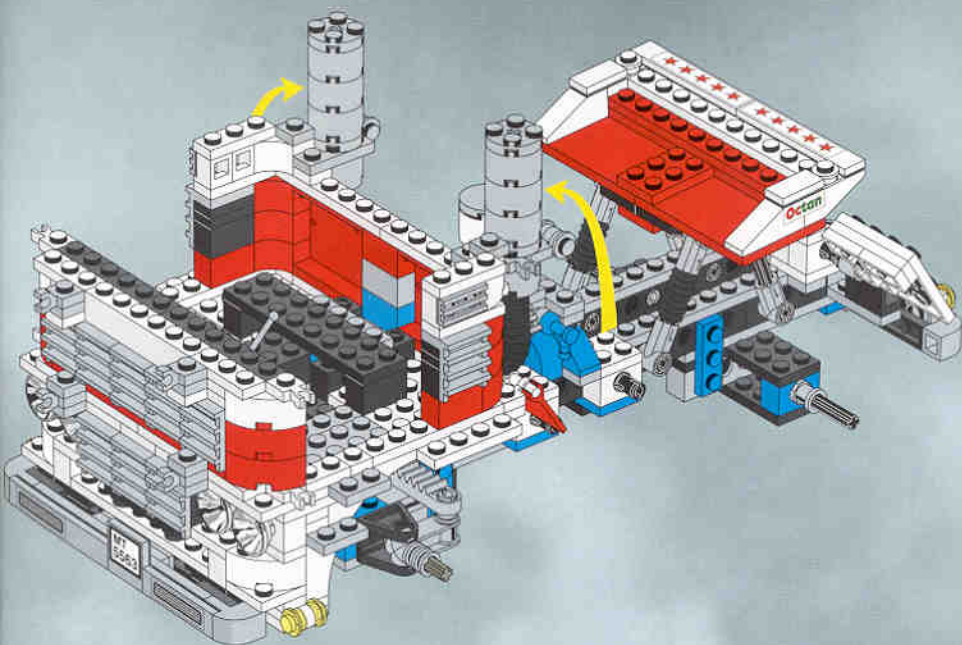
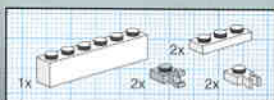



39

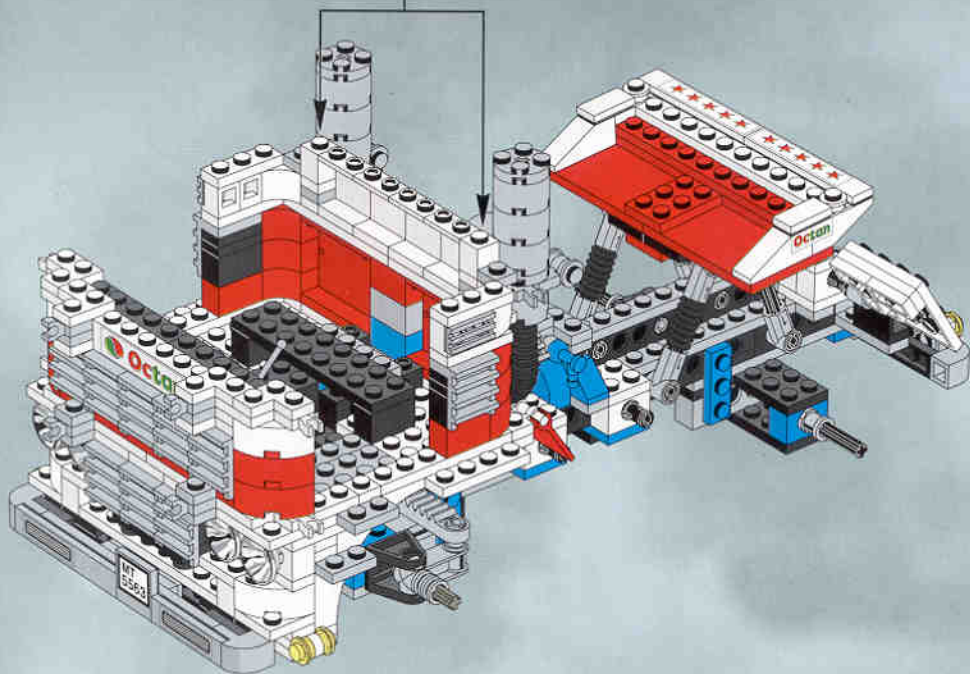
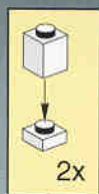

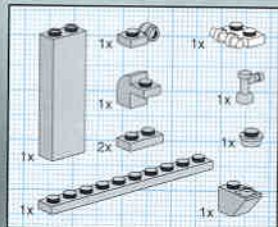

40

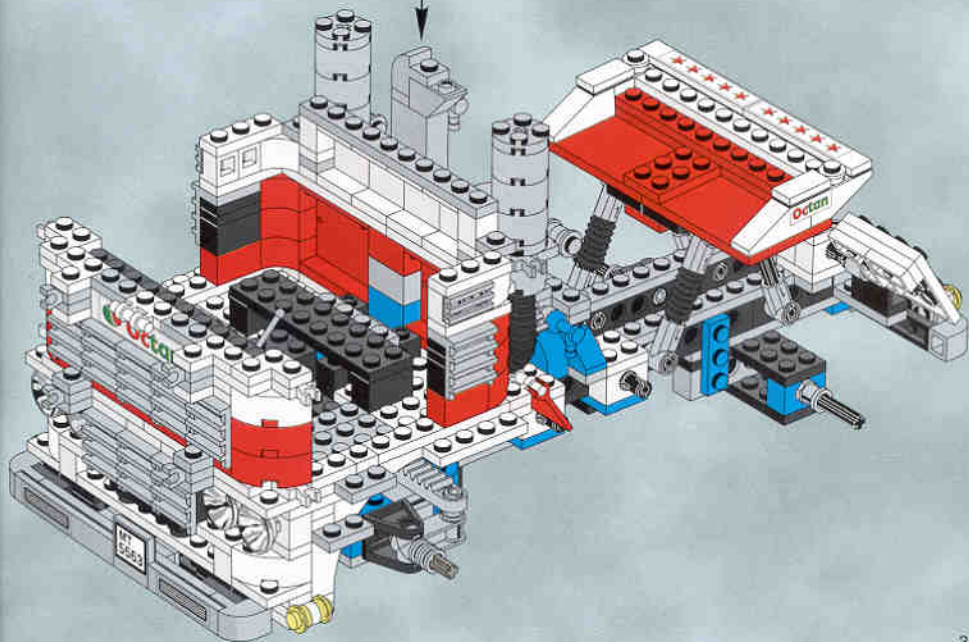
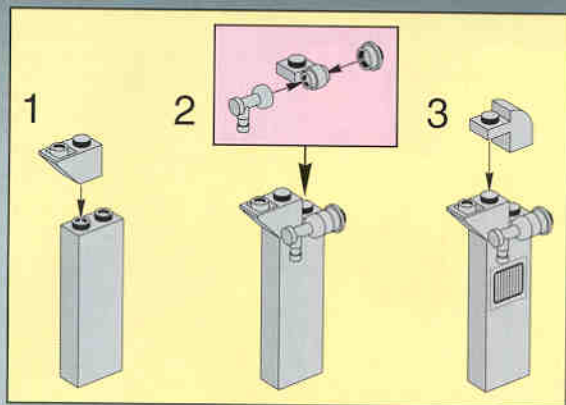

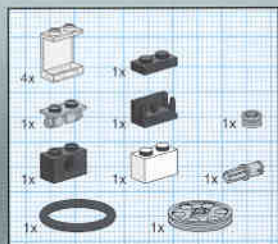

41

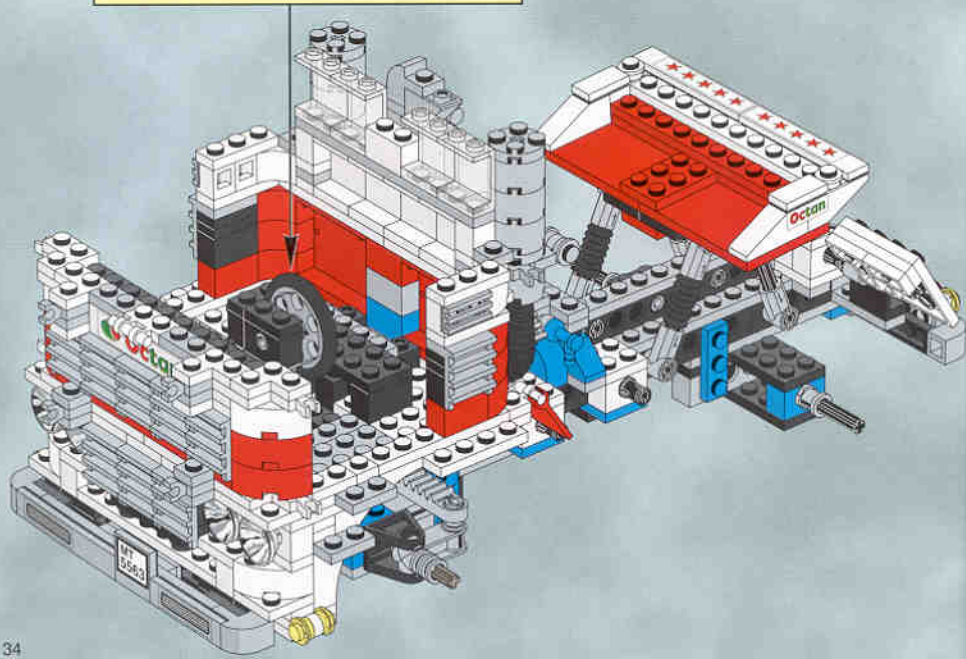
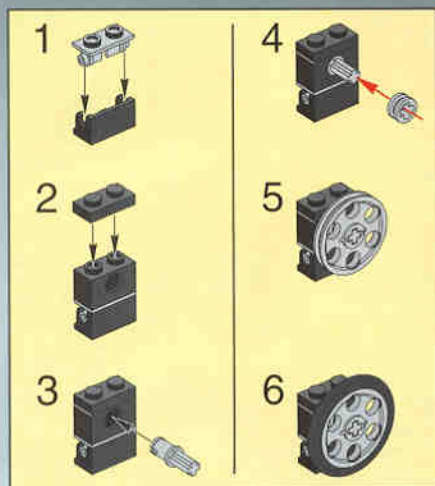

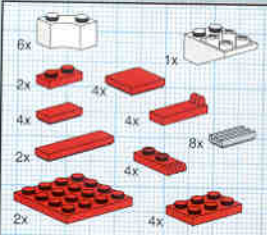

42

1. Start with a 4x4 red Technic plate.

2. Attach a 1x2 grey Technic plate to the top edge of the 4x4 red plate.

3. Attach a 1x2 red Technic plate to the top edge of the 1x2 grey plate.

4. Attach a 1x2 red Technic plate to the top edge of the 1x2 red plate.

5. Attach a 1x2 red Technic plate to the top edge of the 1x2 red plate.

2x

Main assembly diagram showing the sub-assembly being attached to a larger white and red LEGO Technic model. The sub-assembly is being attached to the top of the model. A callout box shows the final assembly step:

2x

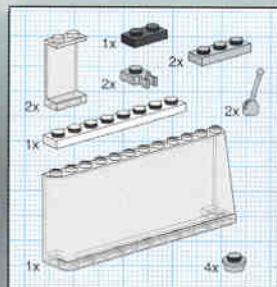

43

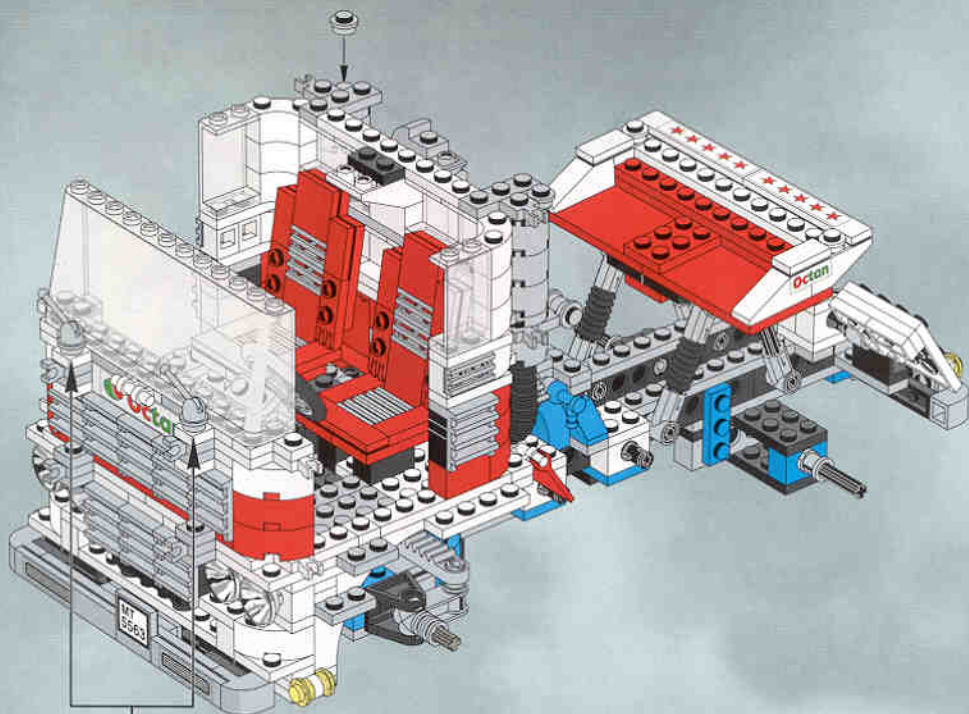

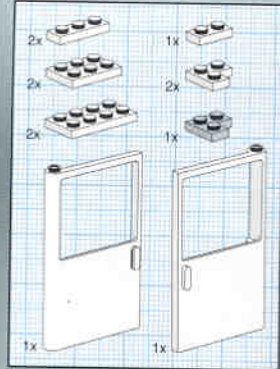

44

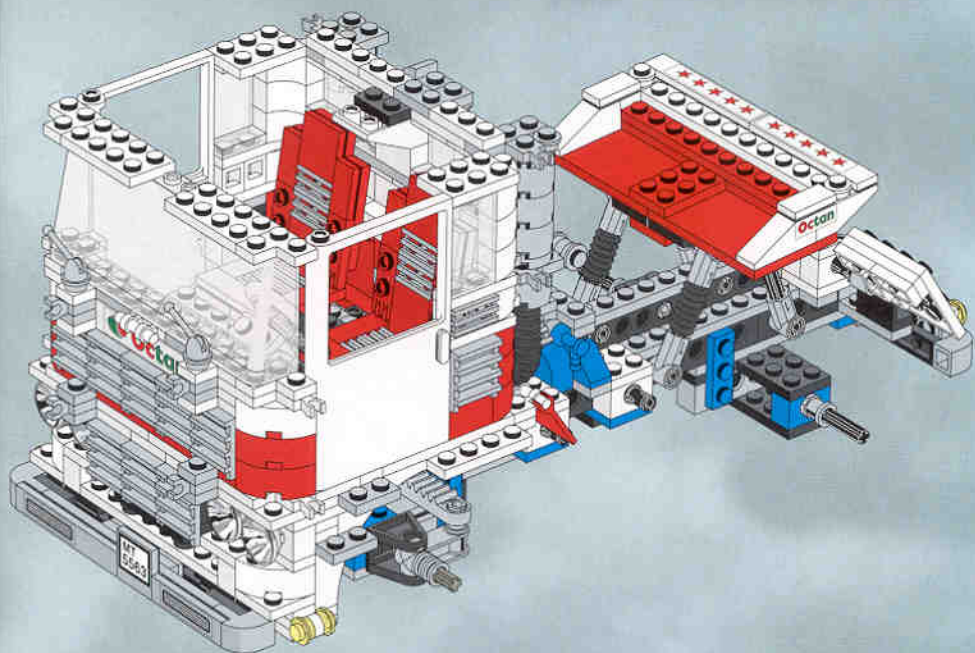

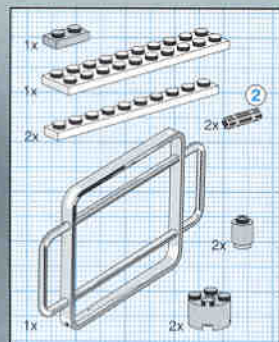

45

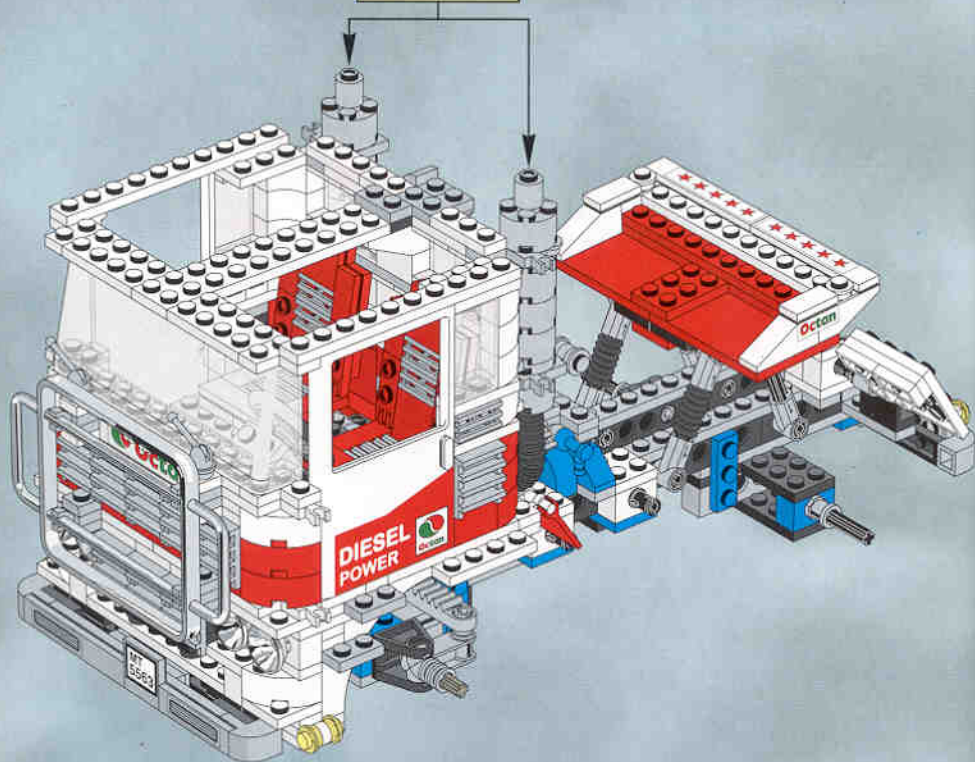

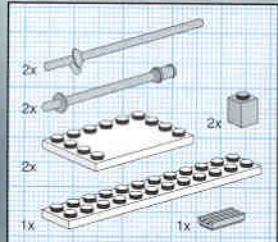

46

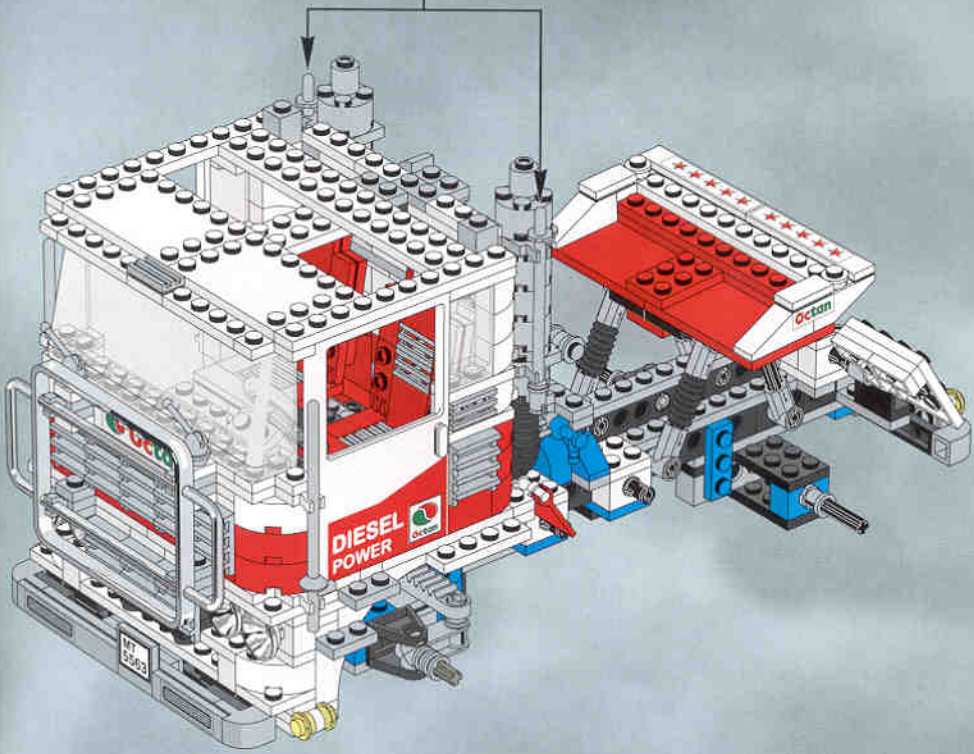
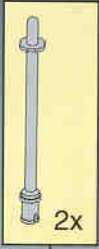

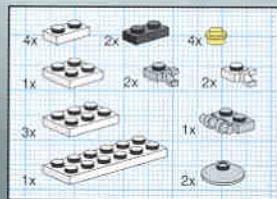

47

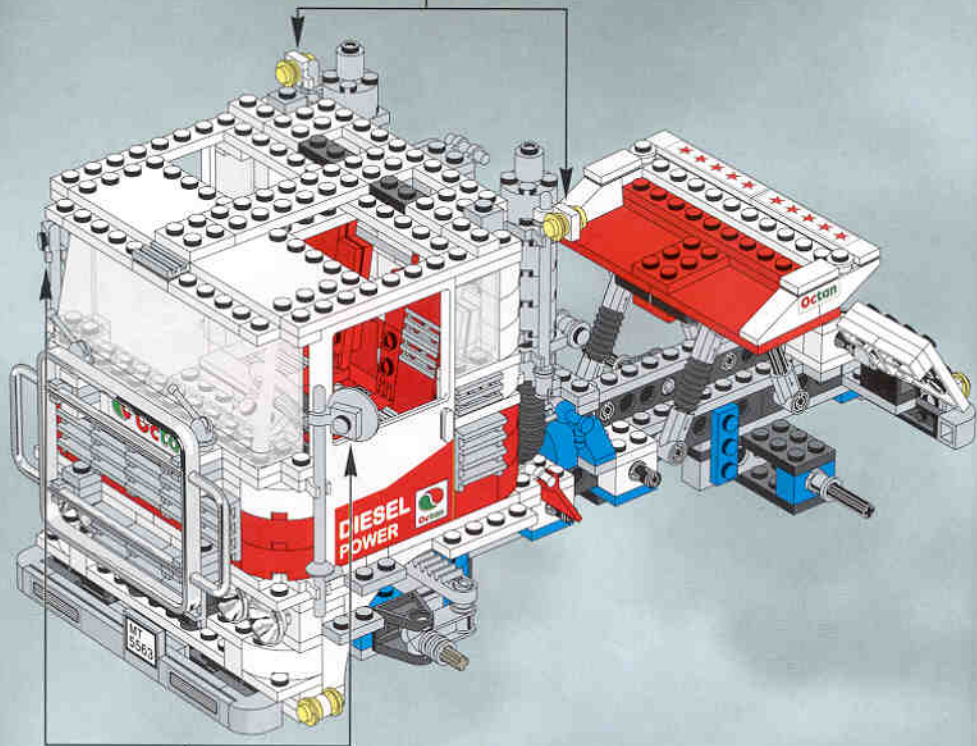
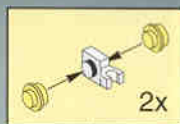

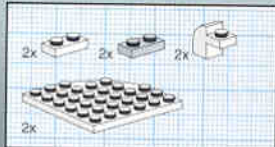

48

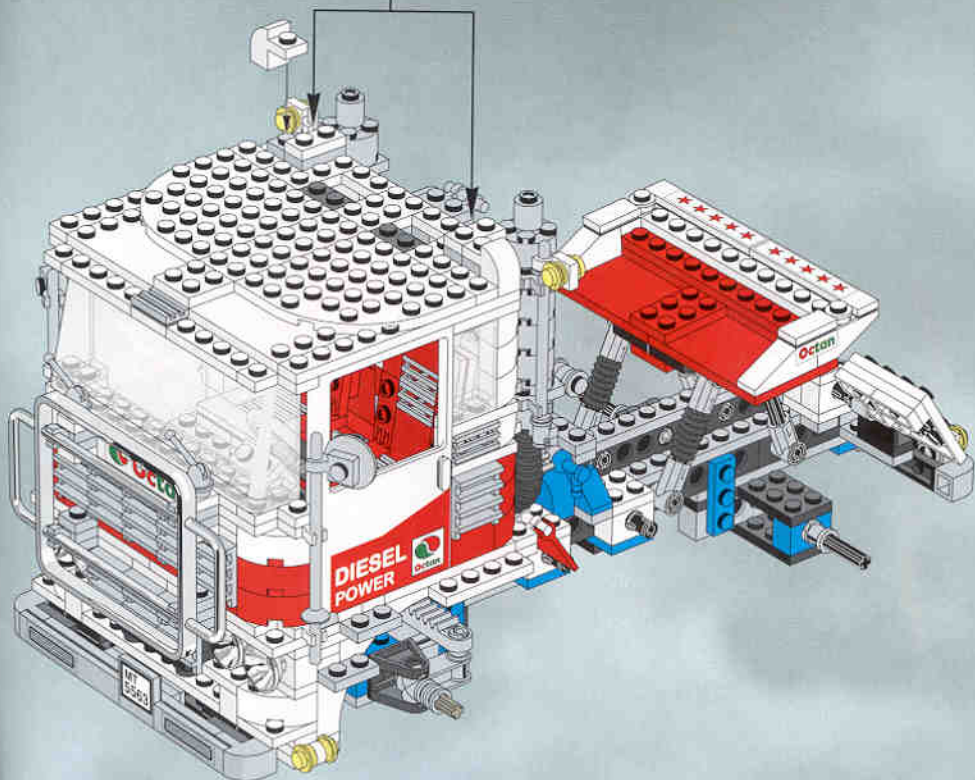
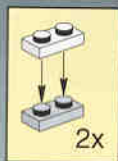

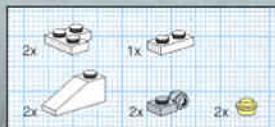

49

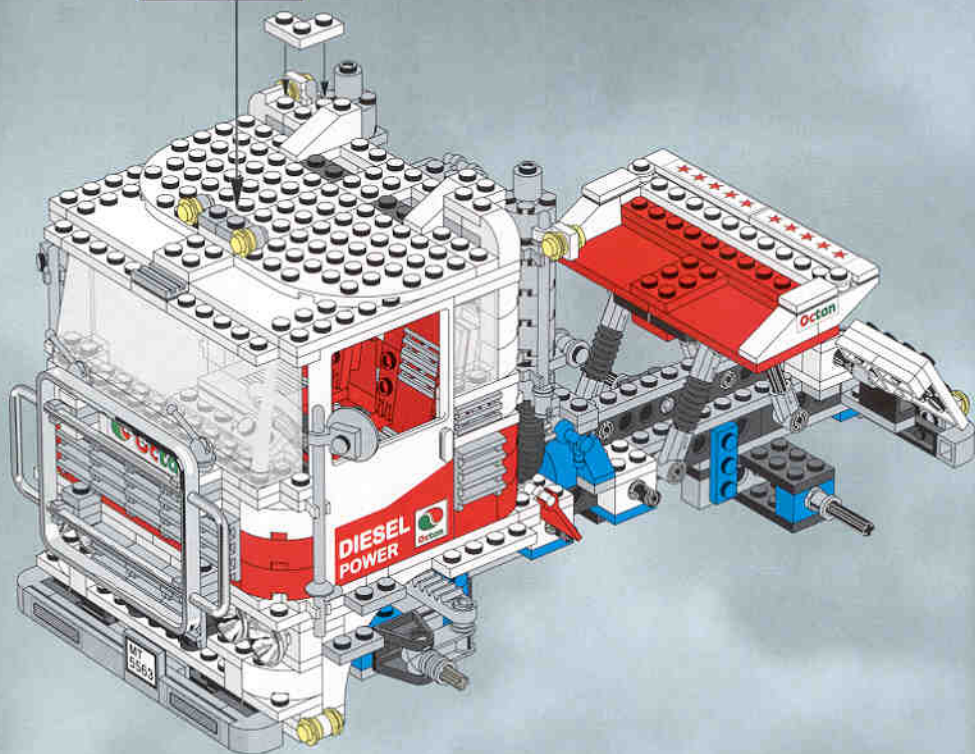
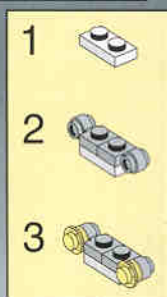

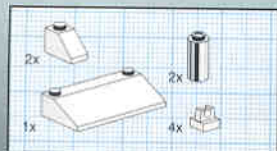

50

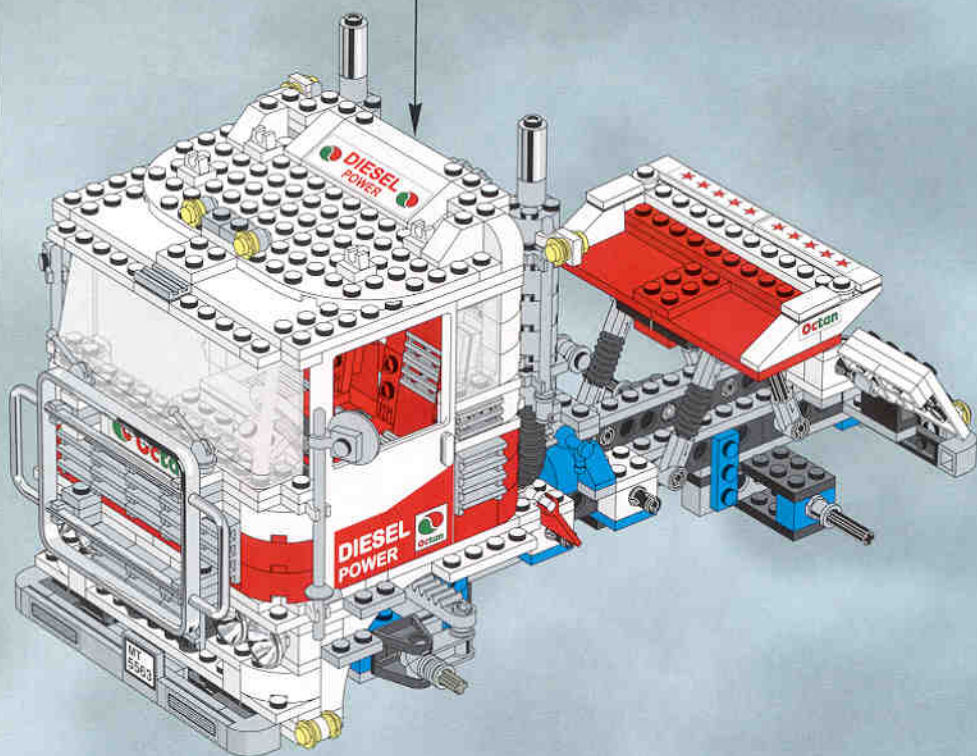
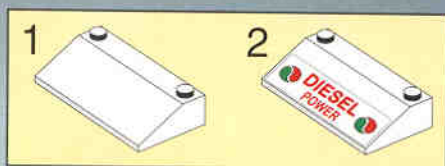

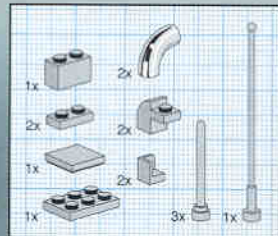

51

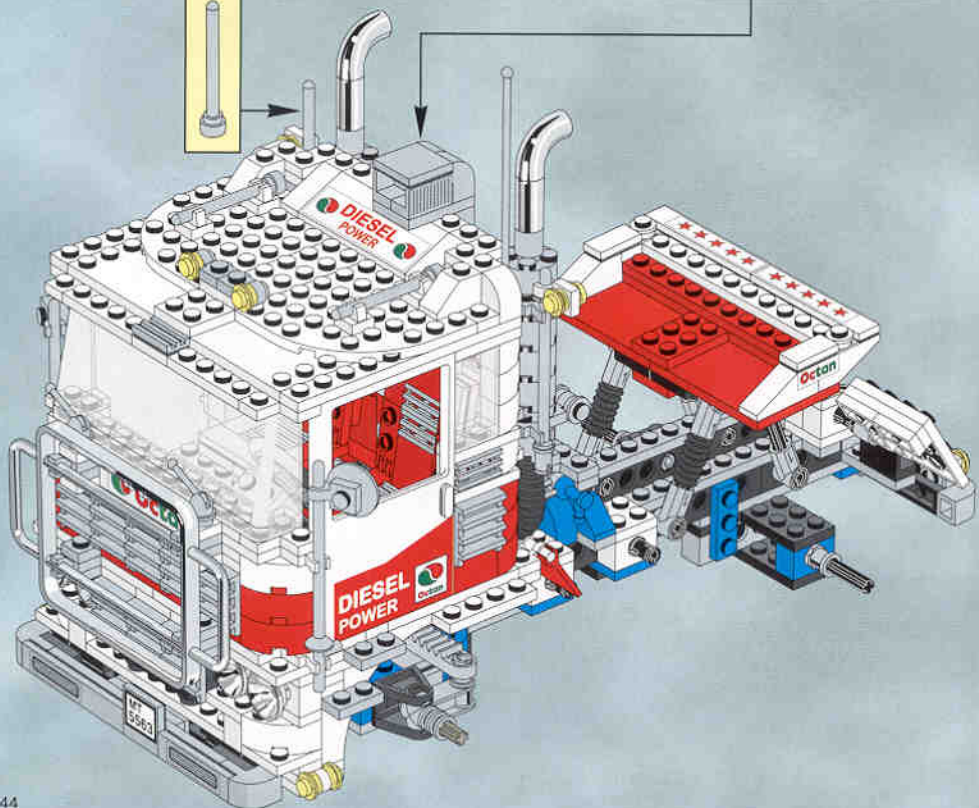
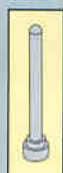
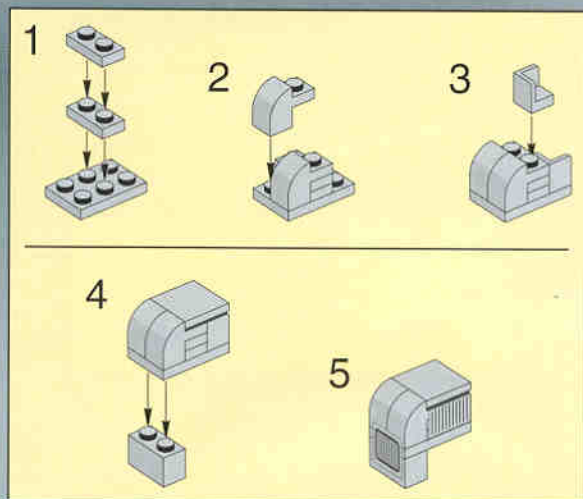



52

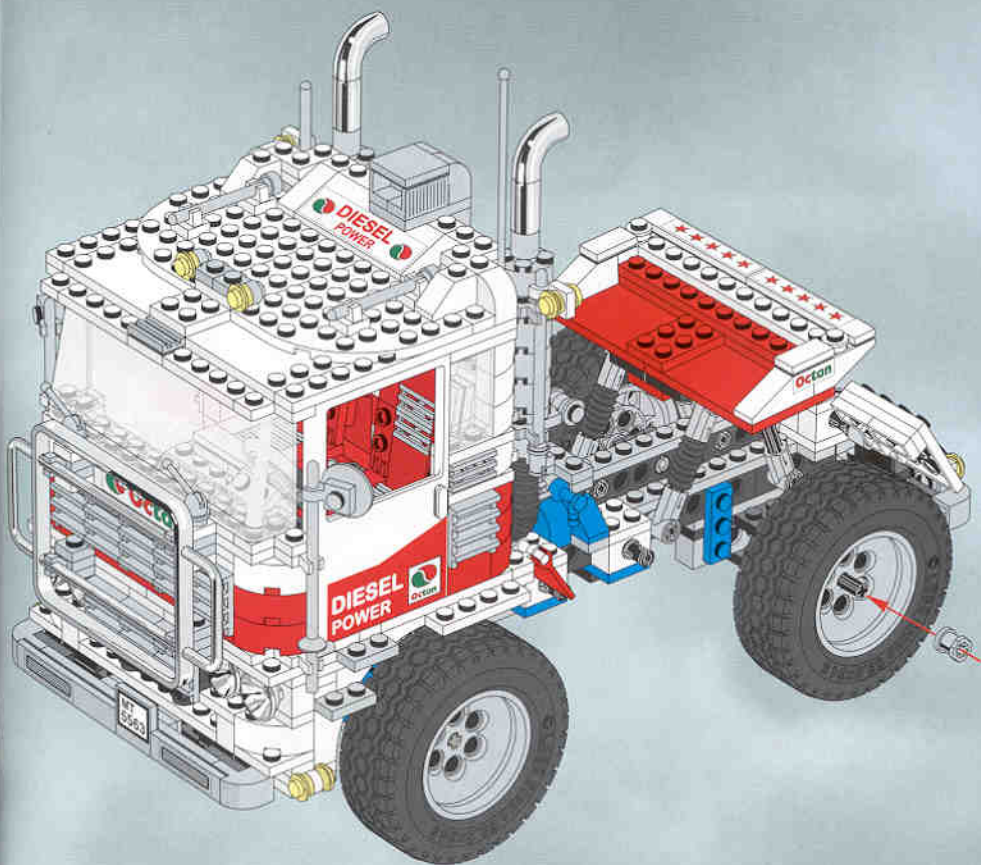

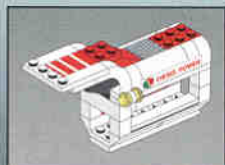

1

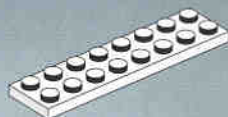

2

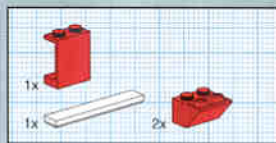
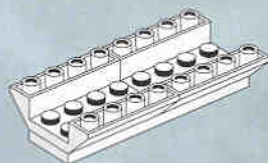

3

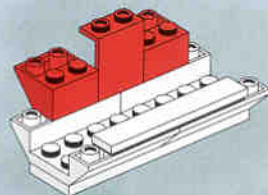

4

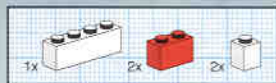
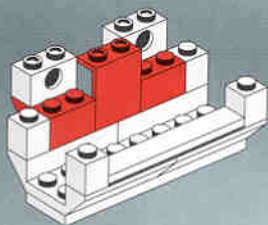

5

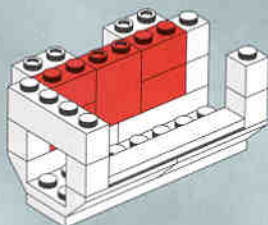

6

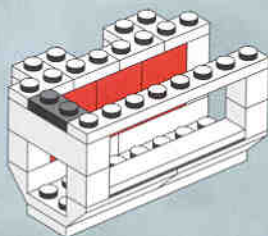

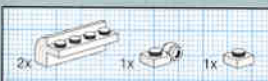

7

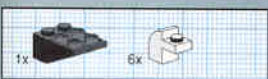
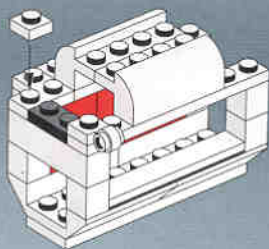

8

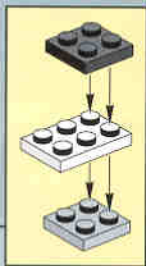
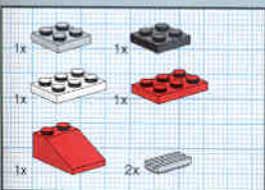
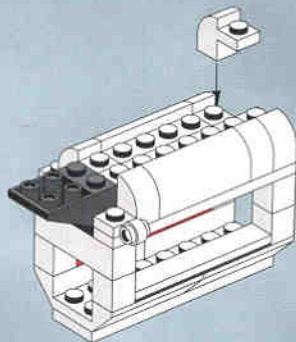

9

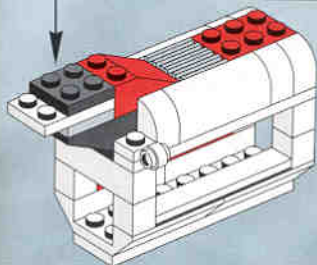

10

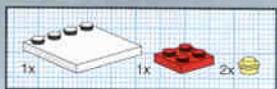
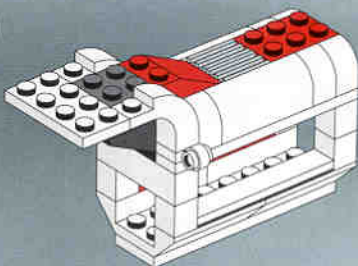

11

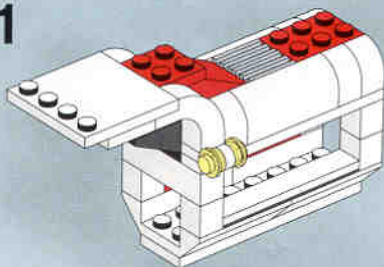

12

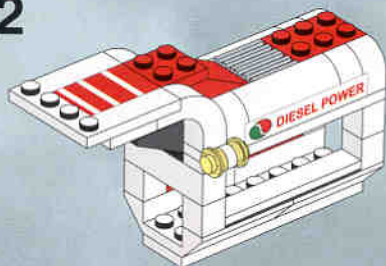

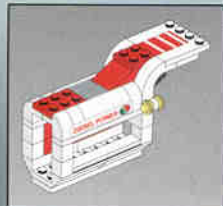

1

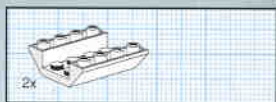
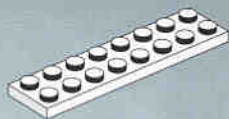

2

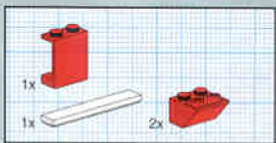
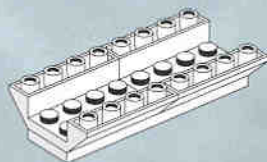

3

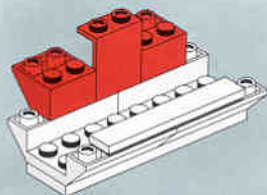

4

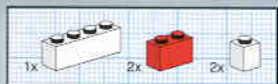
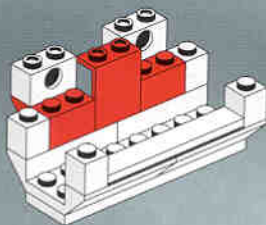

5

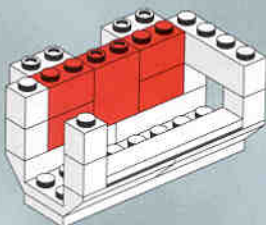

6

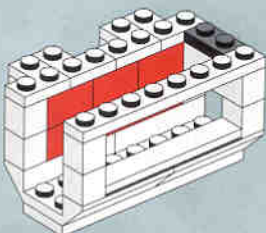

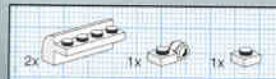

7

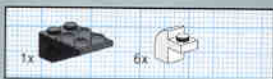
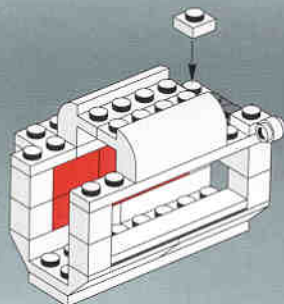

8

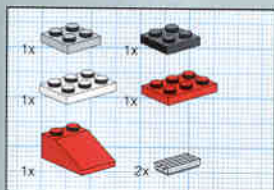
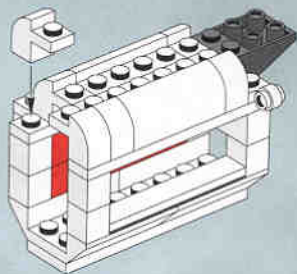

9

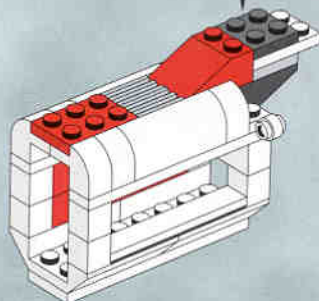

10

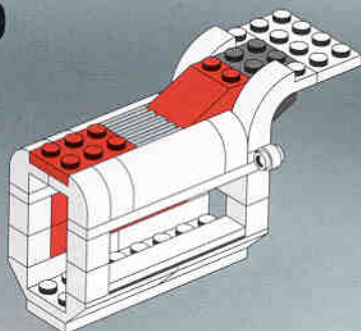

11

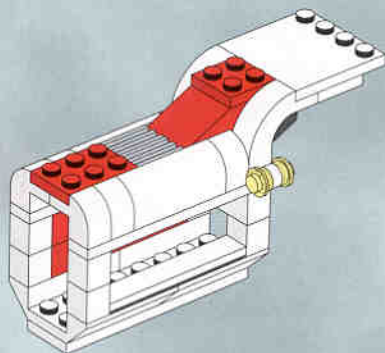

12

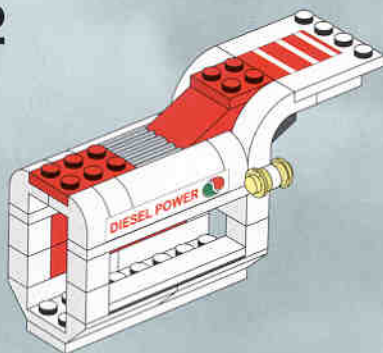

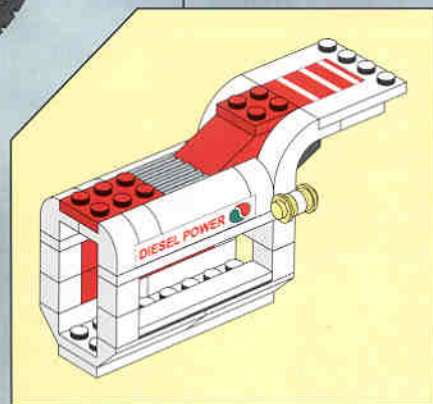
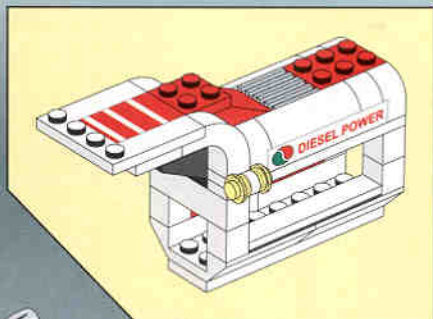
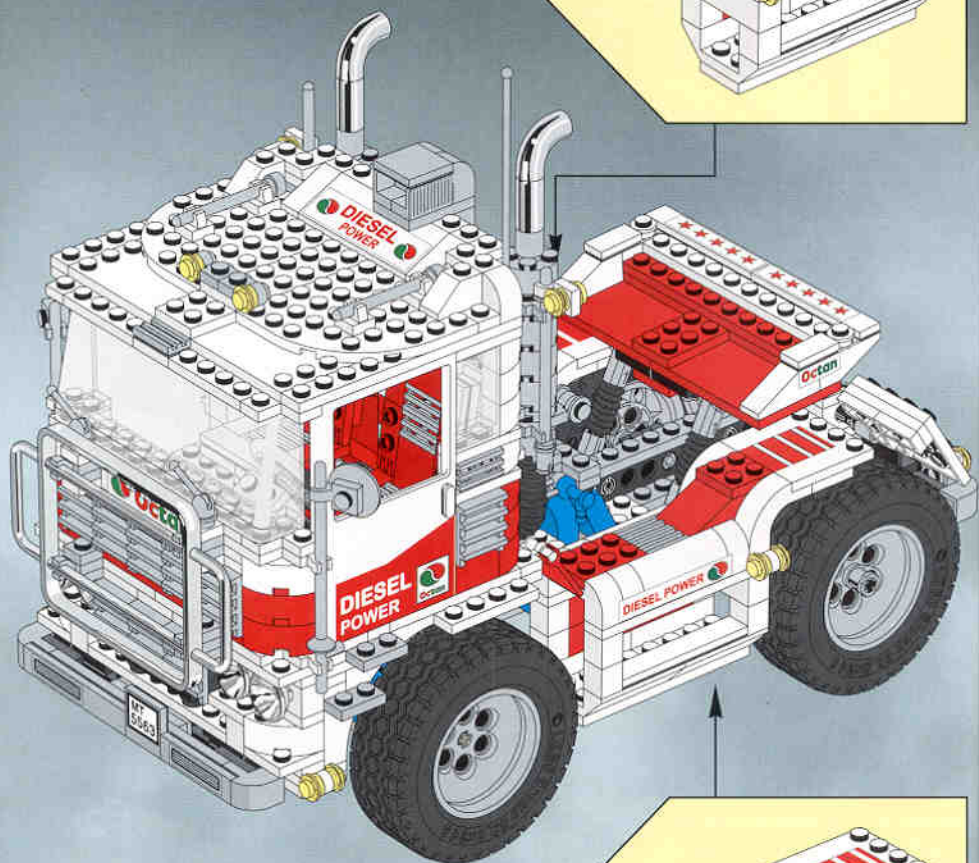



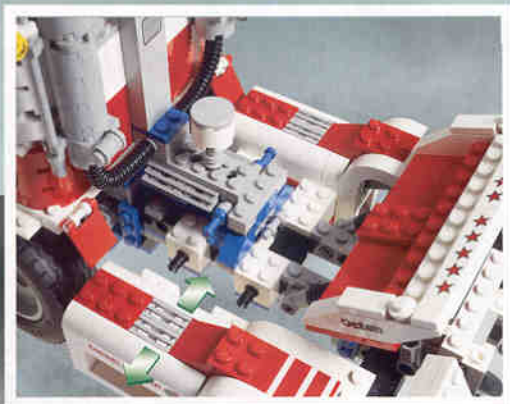
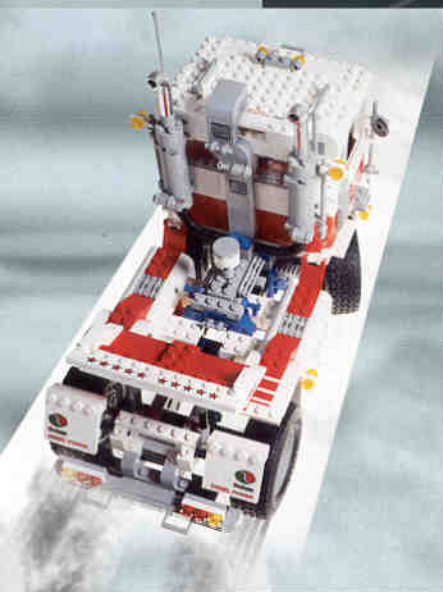



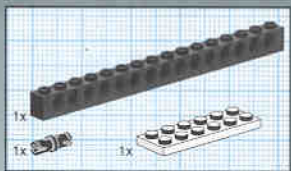
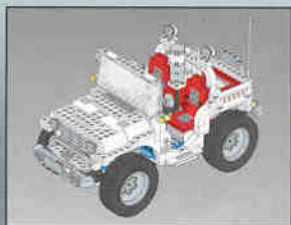

1

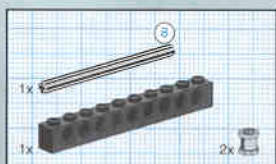
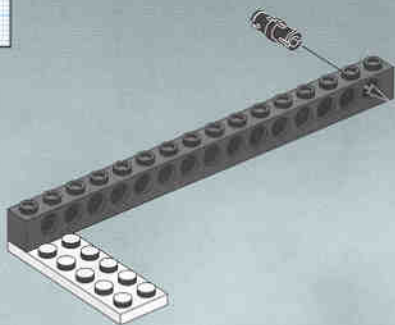

2

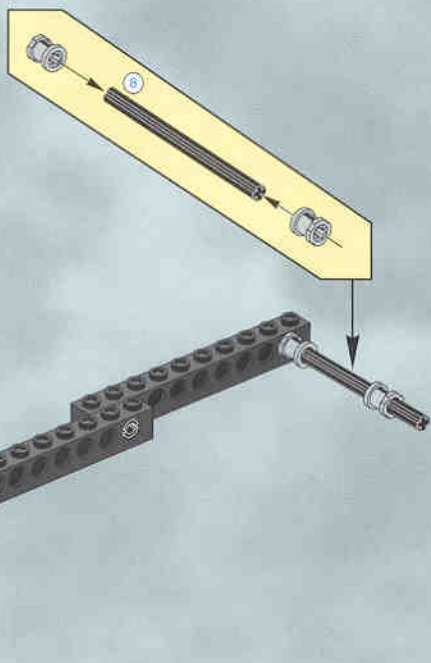



3

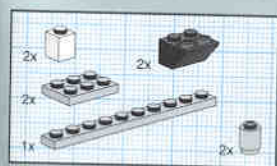
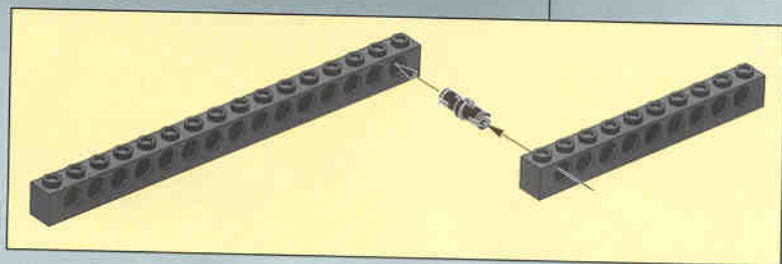
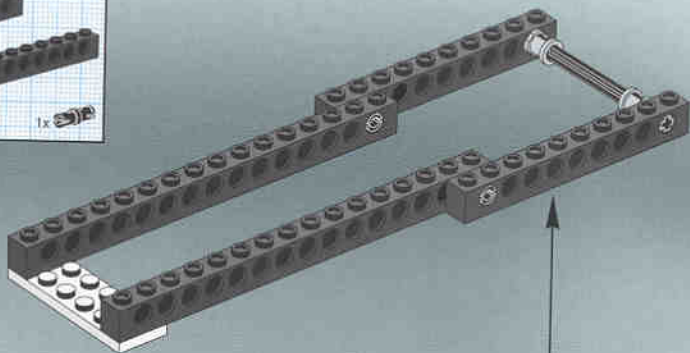

4

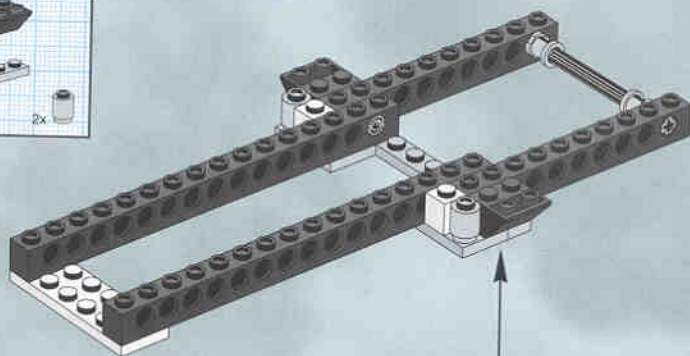

1

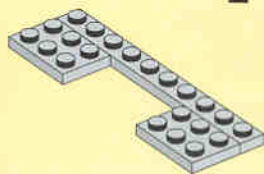

2

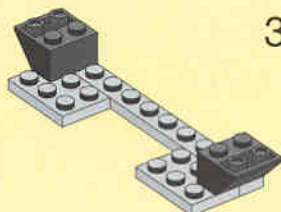

3

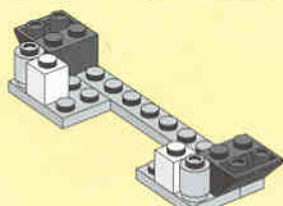



5

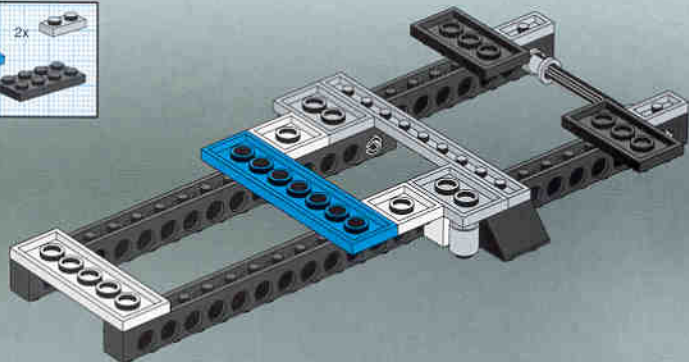

6

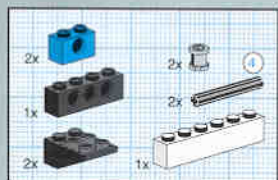
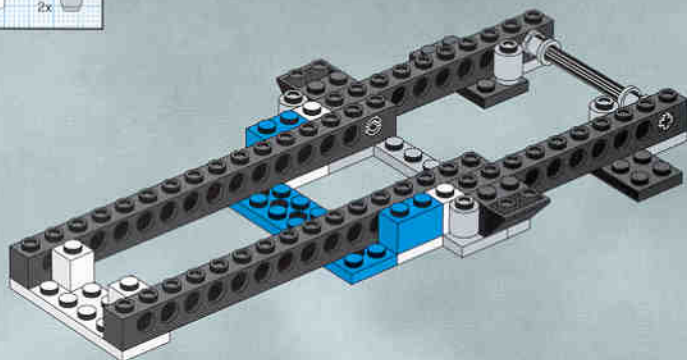

7

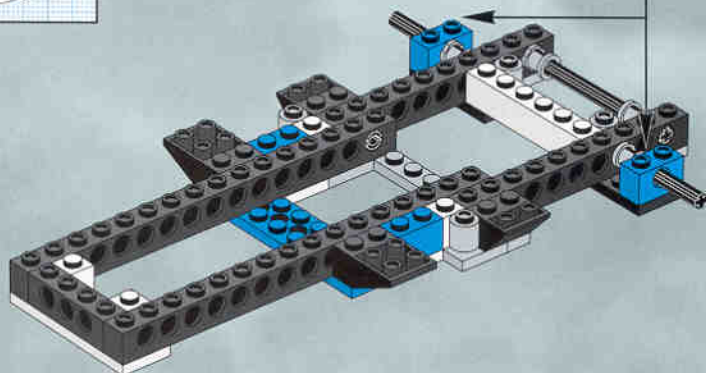
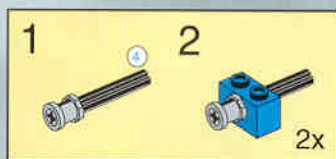



8

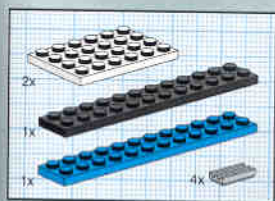
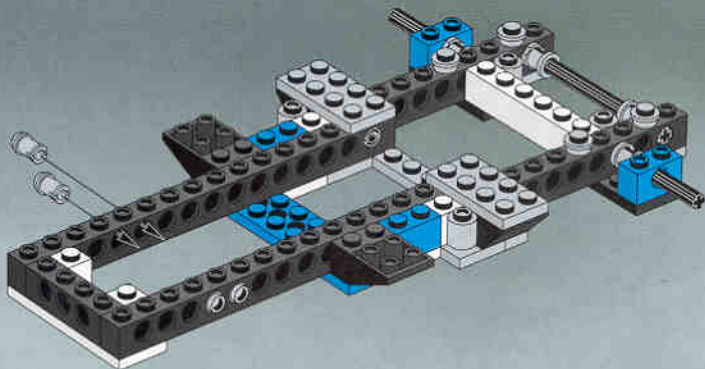

9

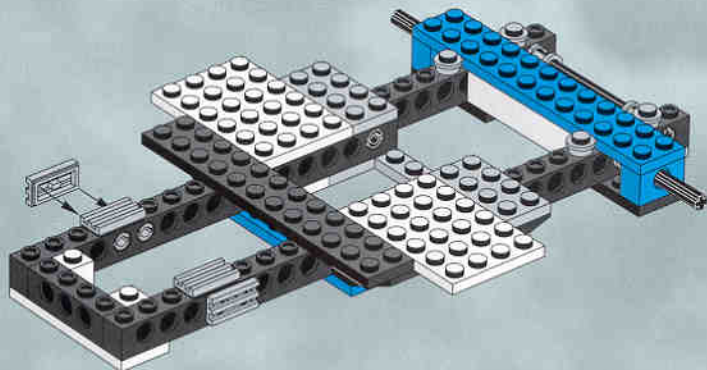

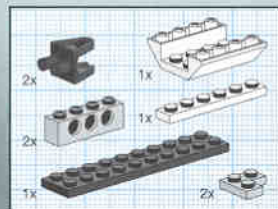

10

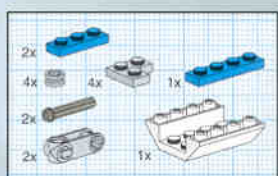
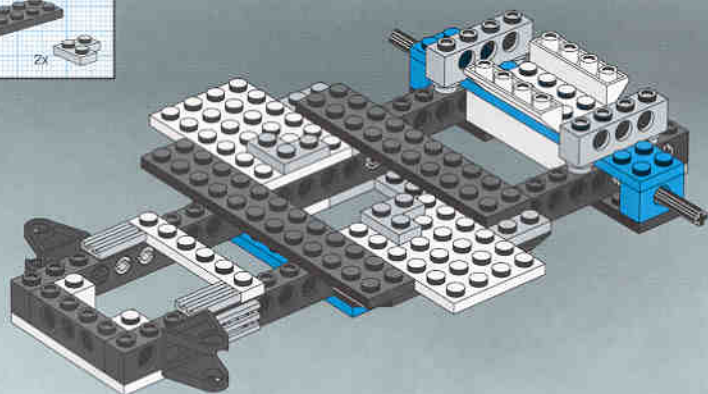

11

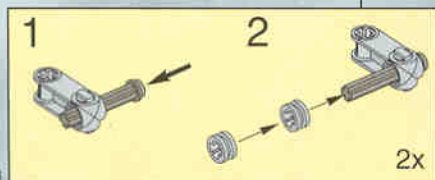
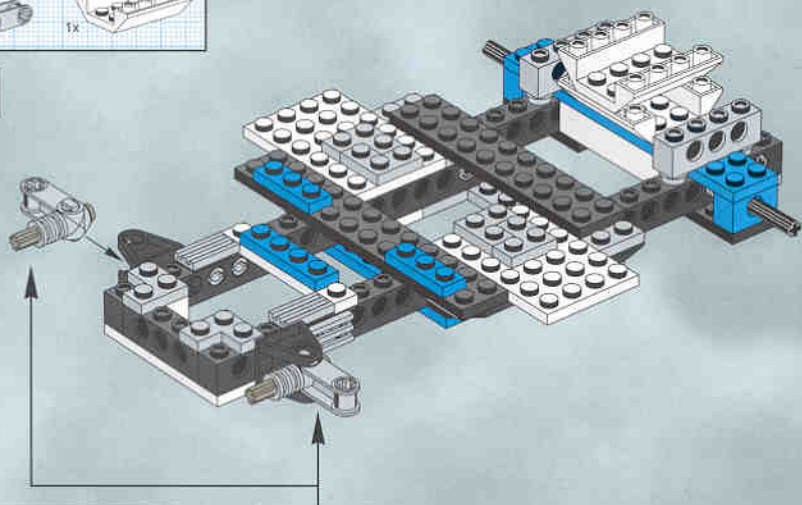

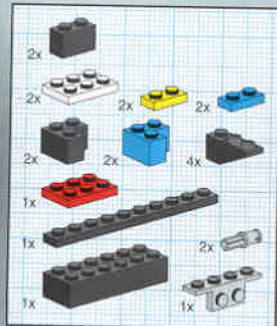

12

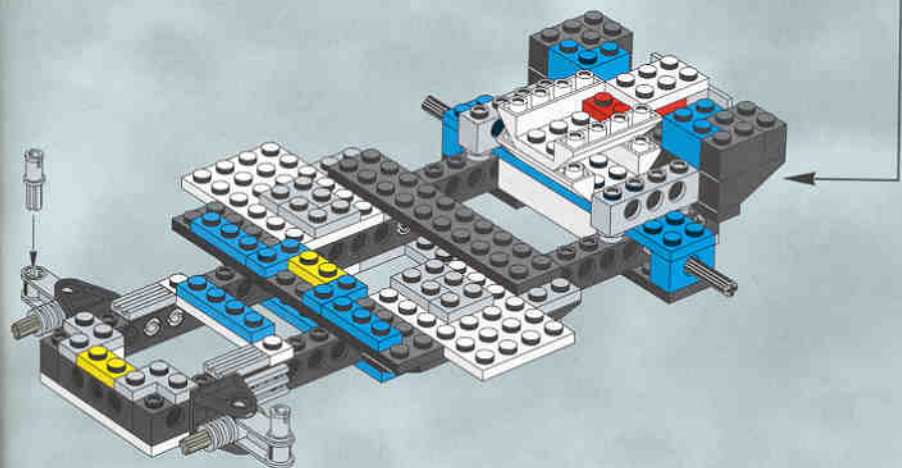
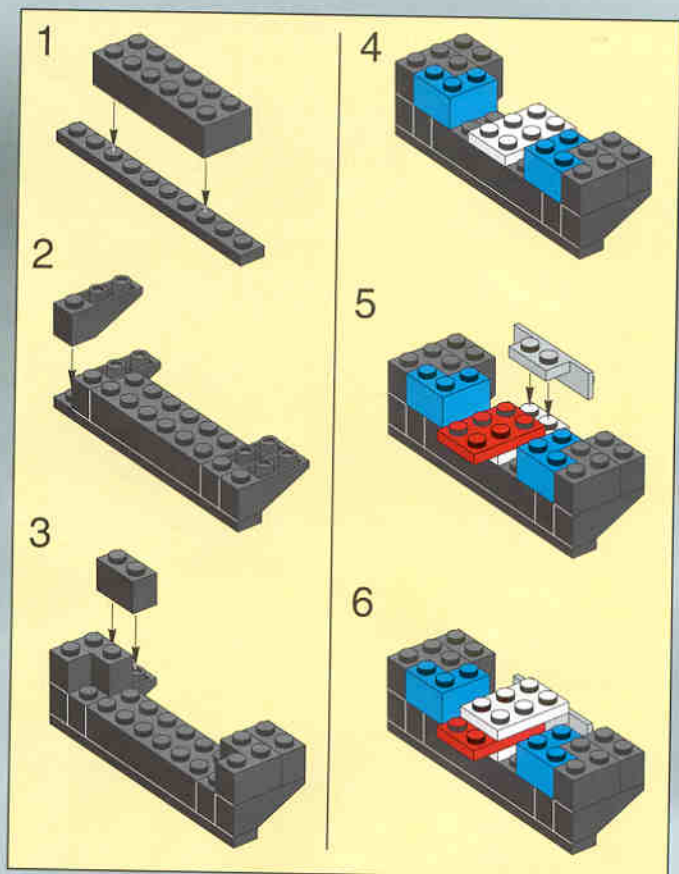

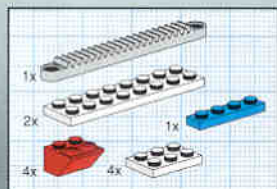

13

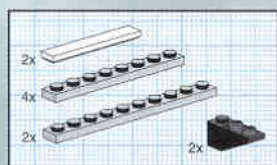
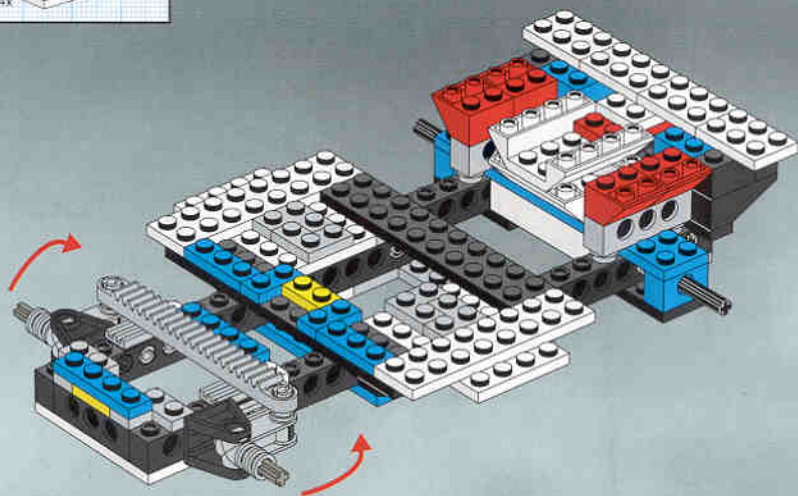

14

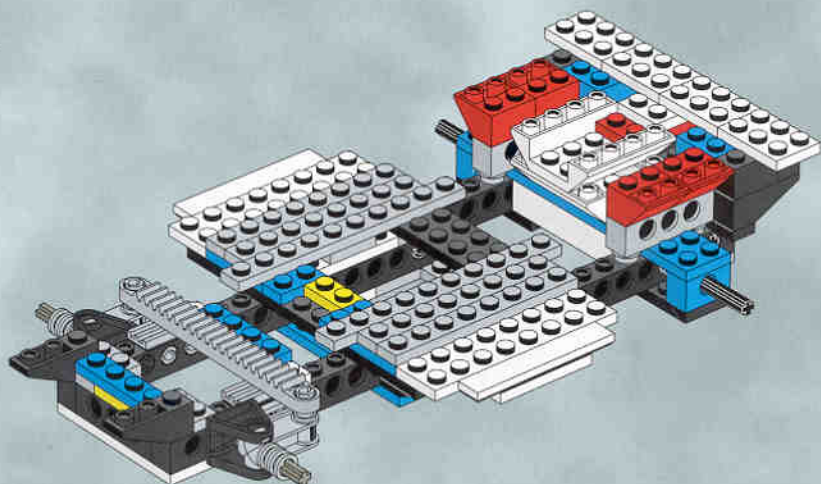

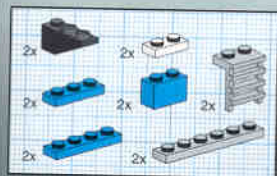

15

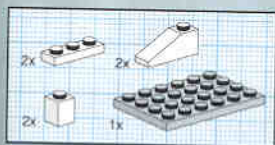
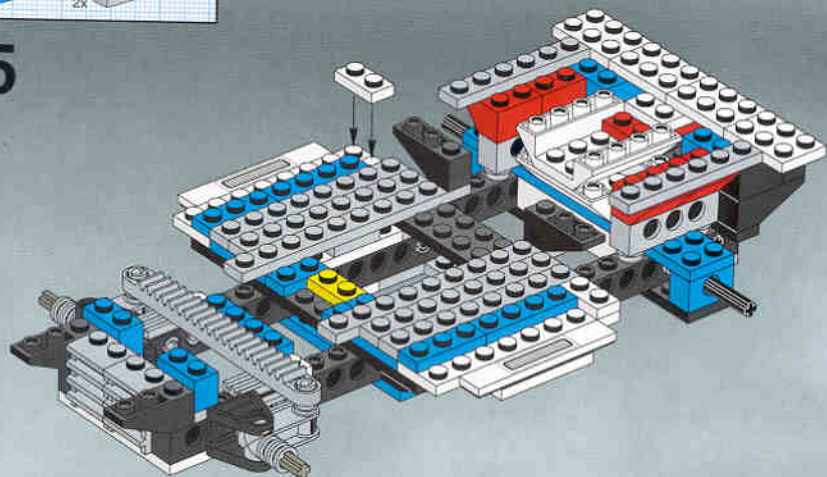

16

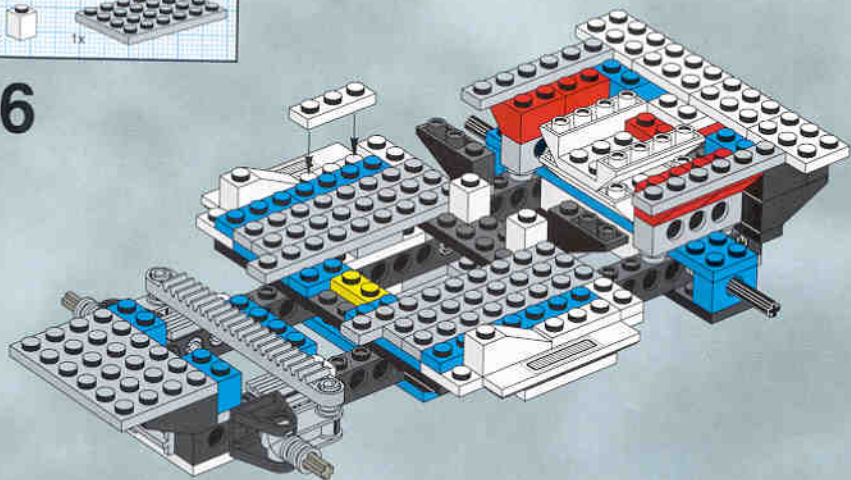



17

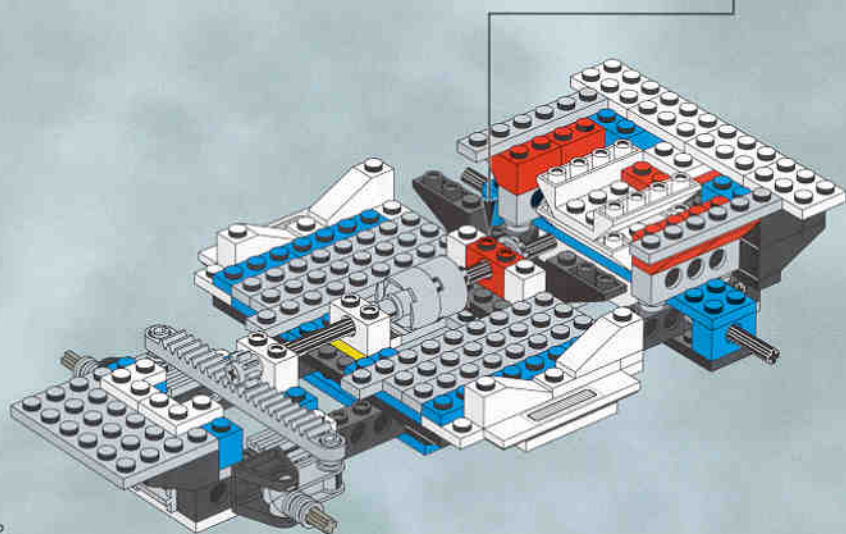
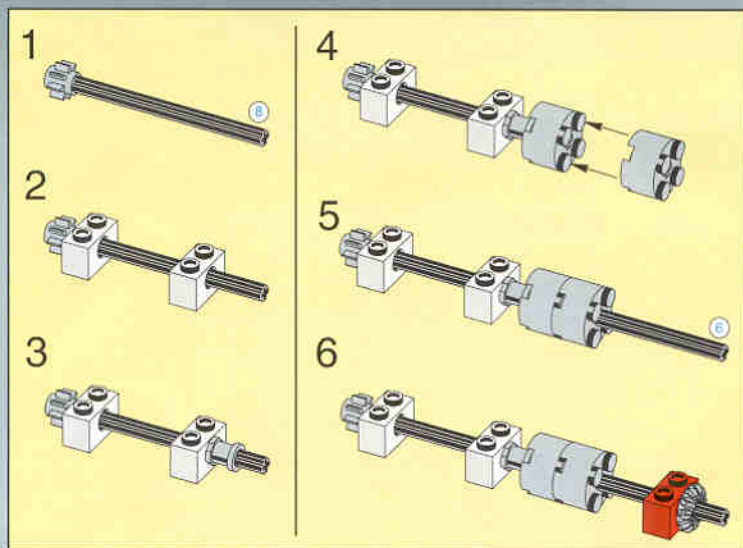

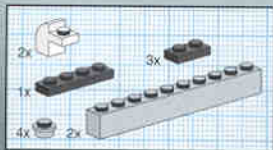

18

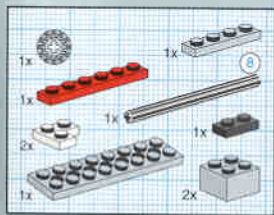
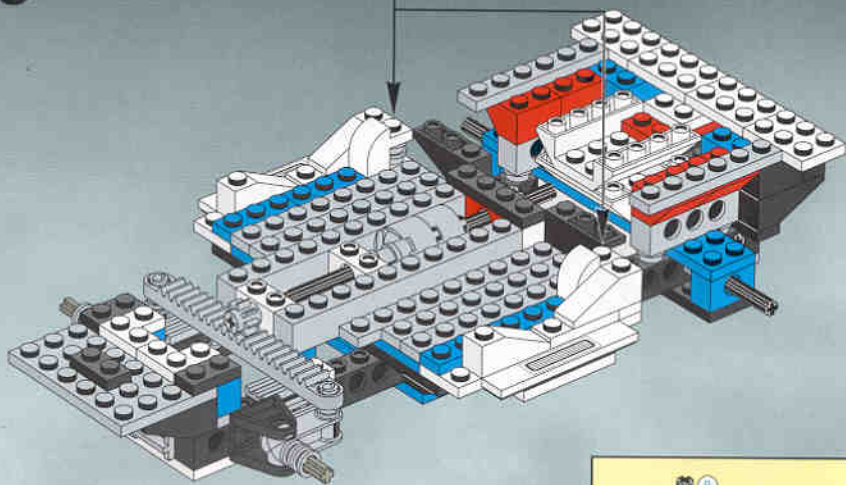

19

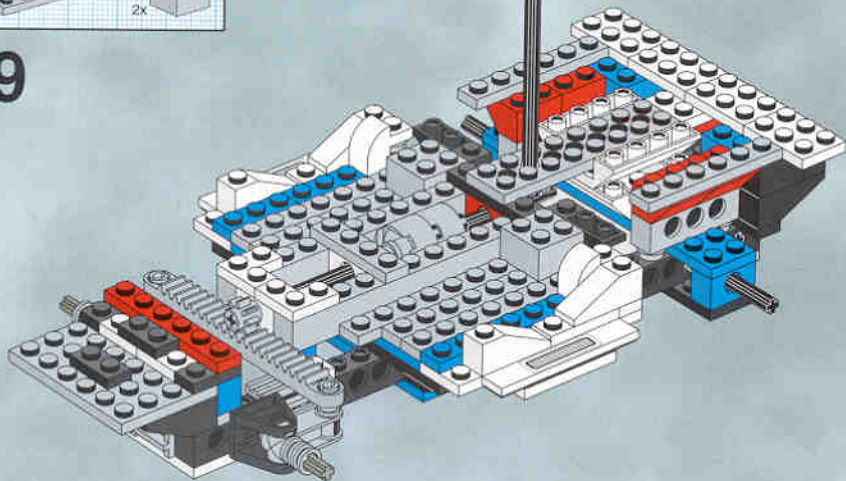
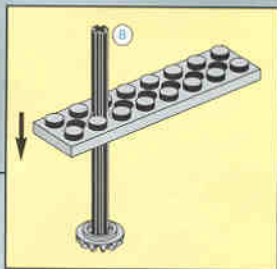

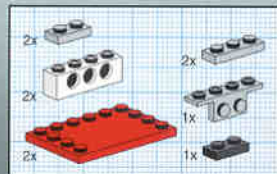

20

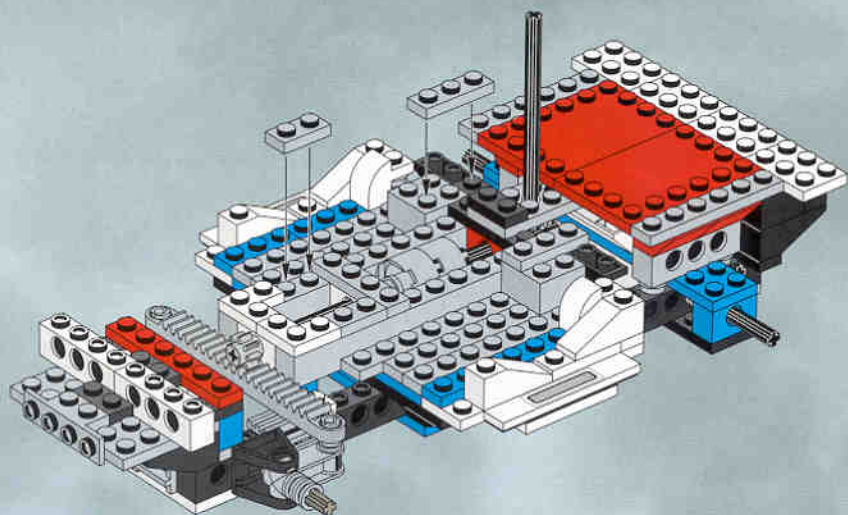

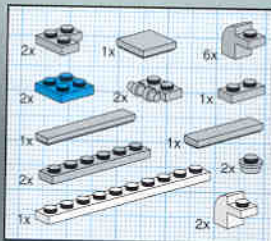

21

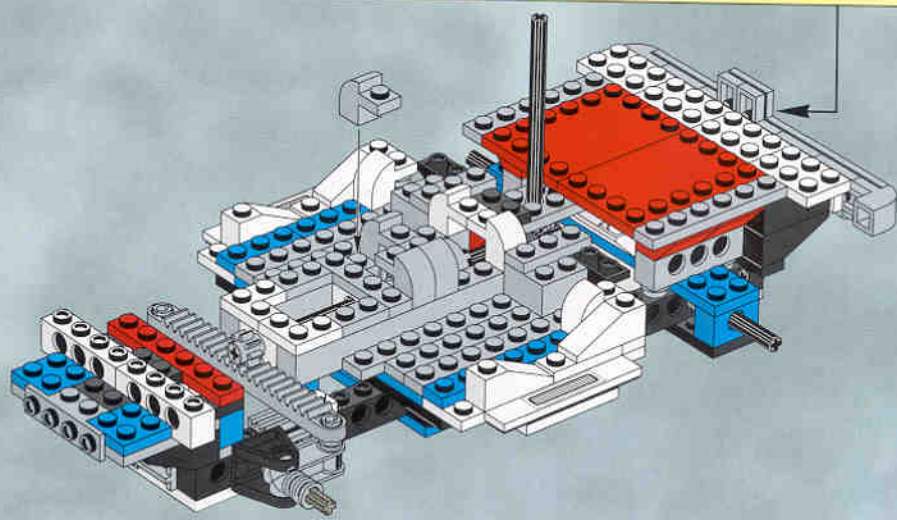
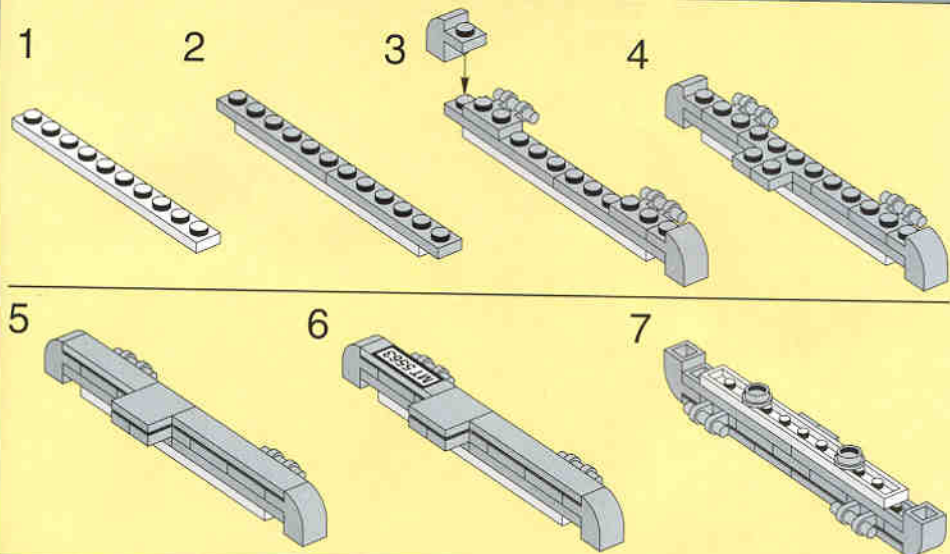

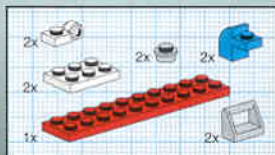

22

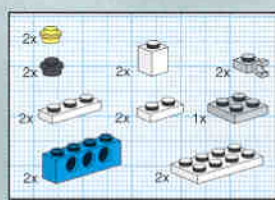
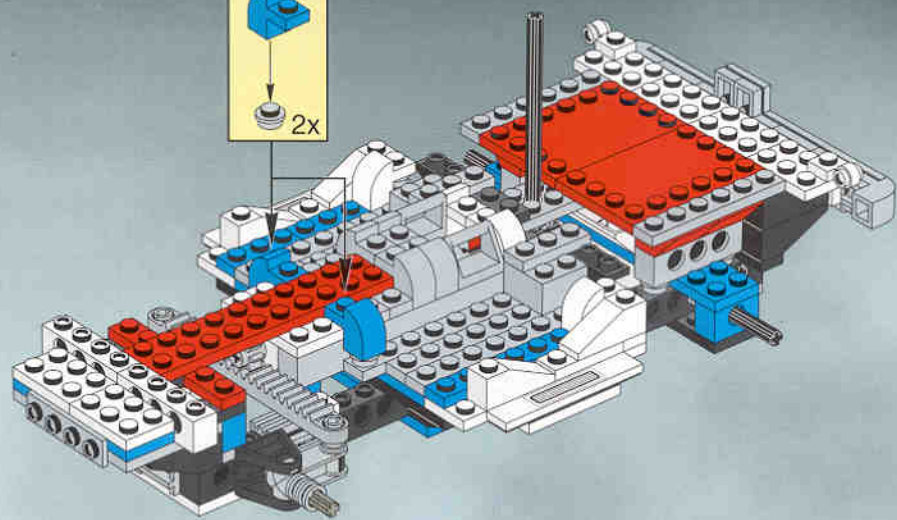
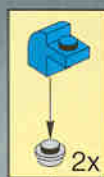

23

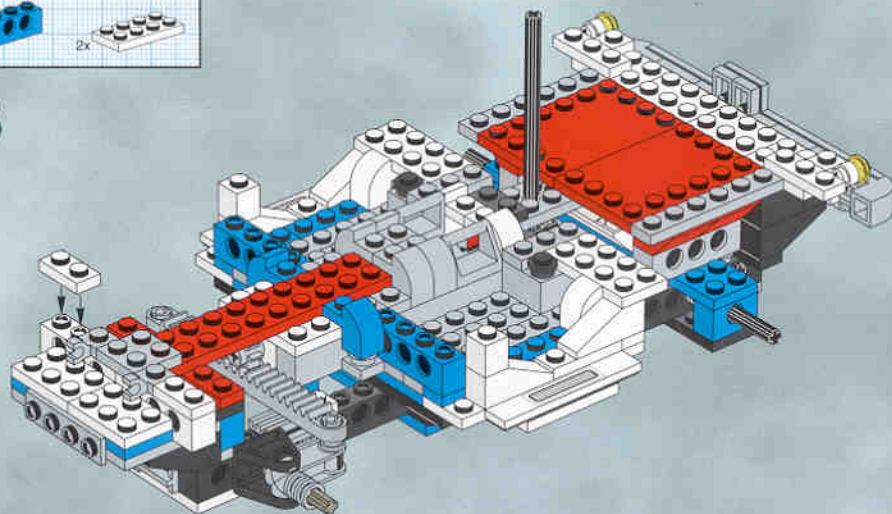



24

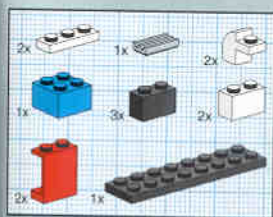
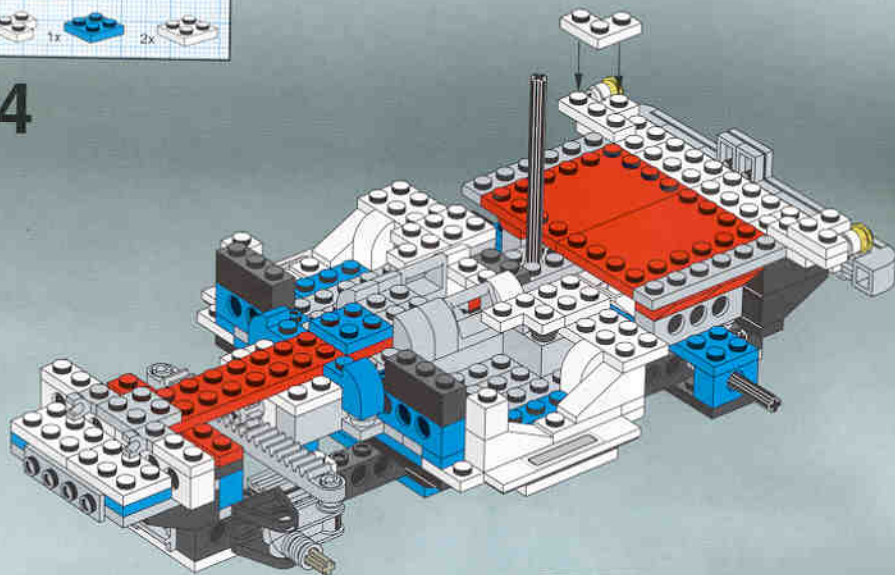

25

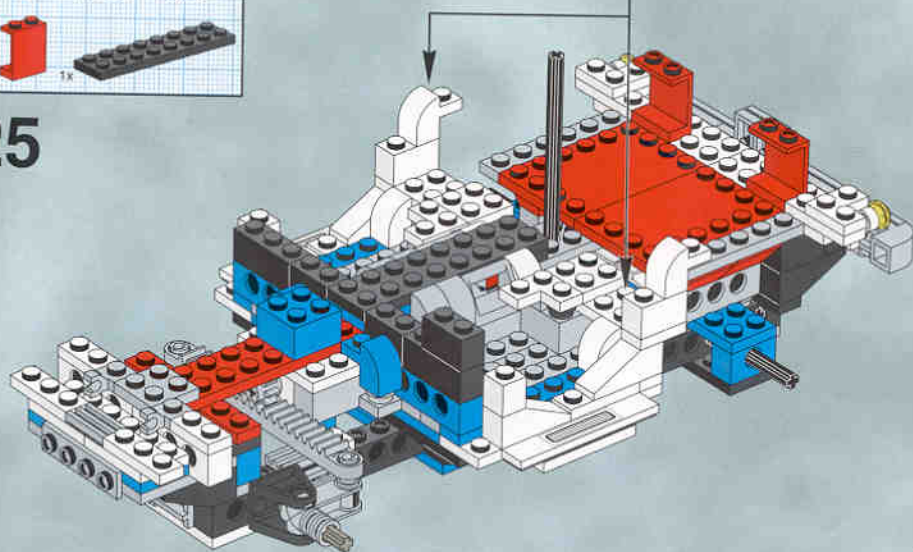

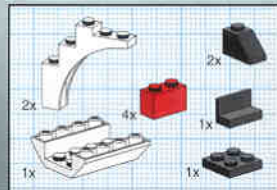

26

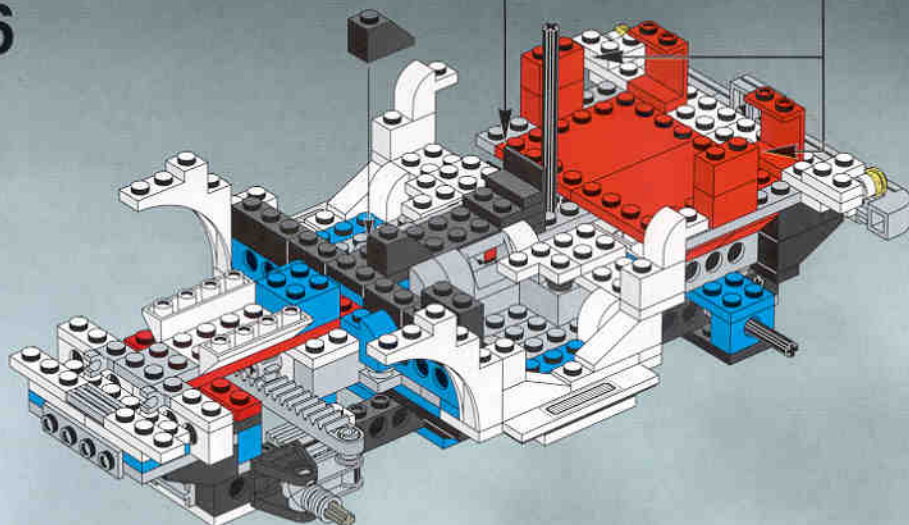
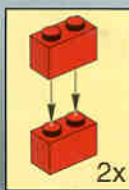

27

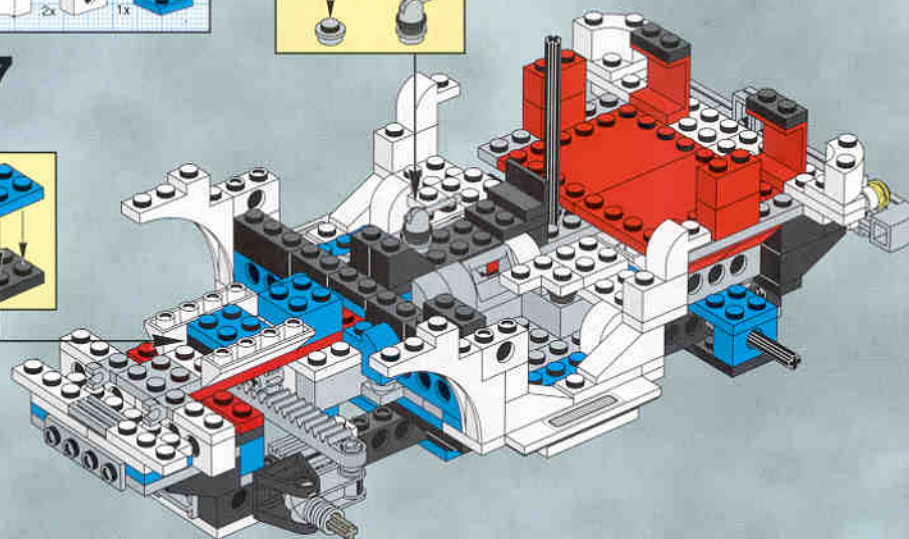

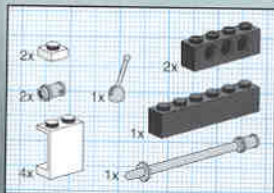

28

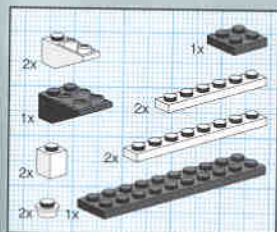
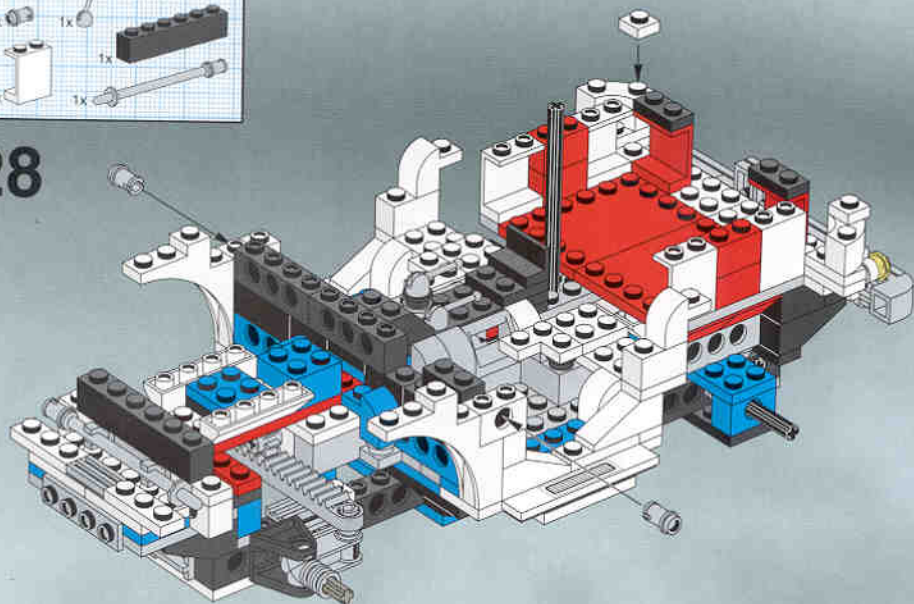

29

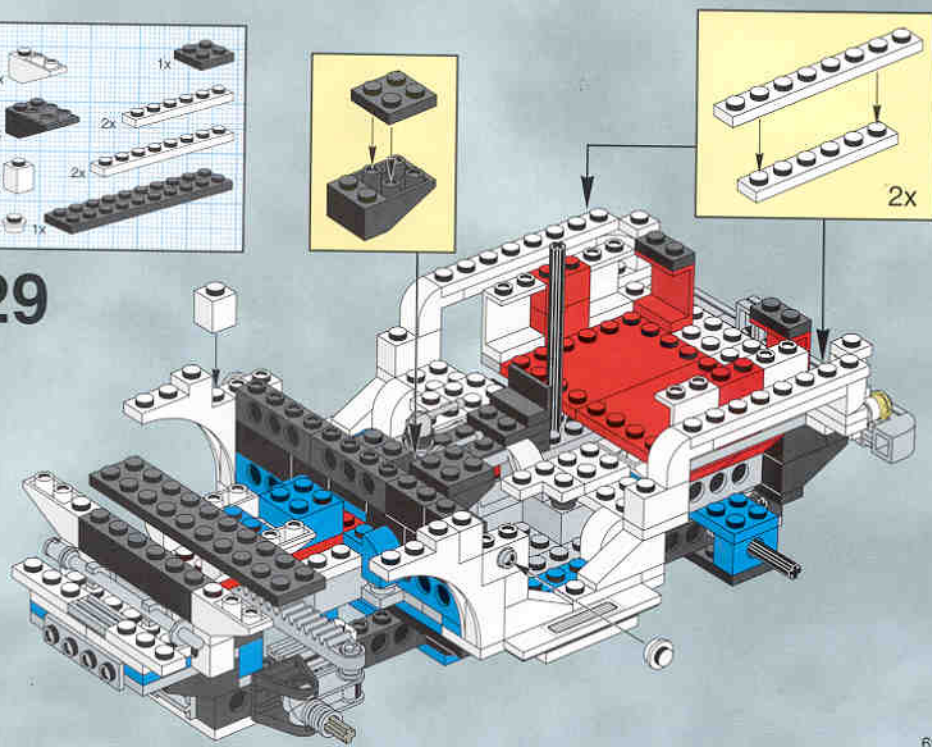

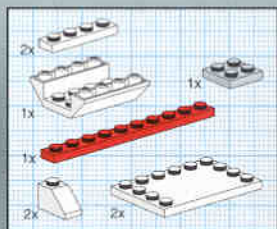

30

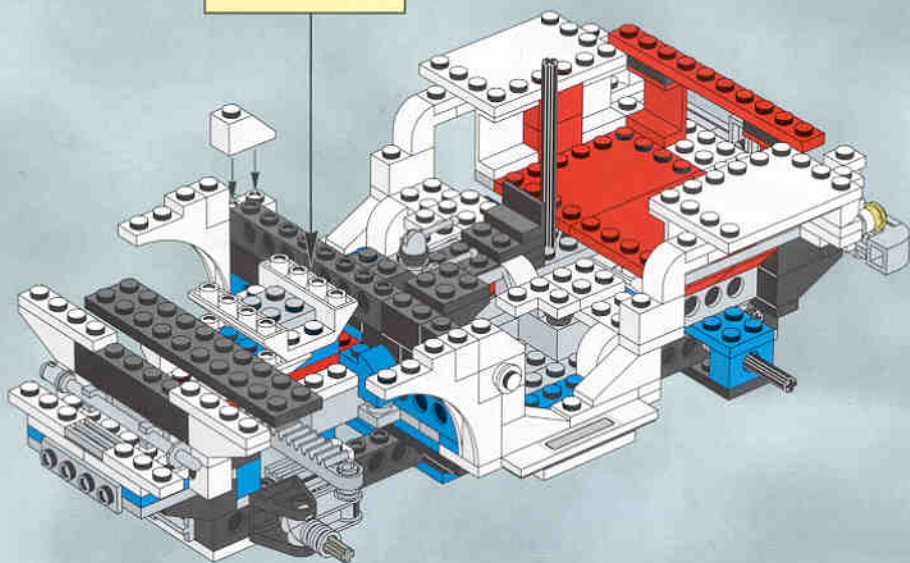
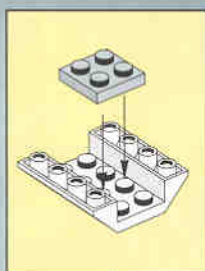

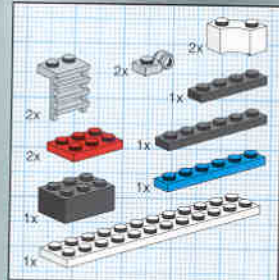

31

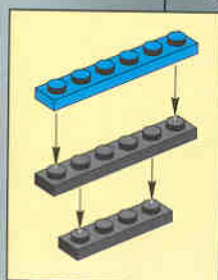
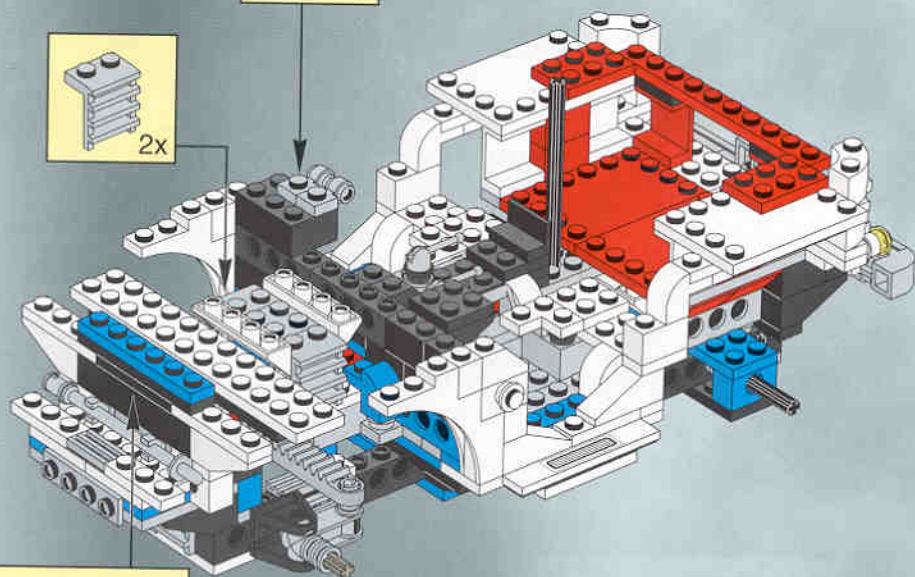
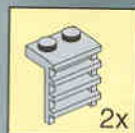

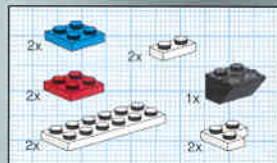

32

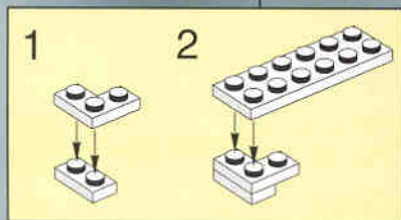
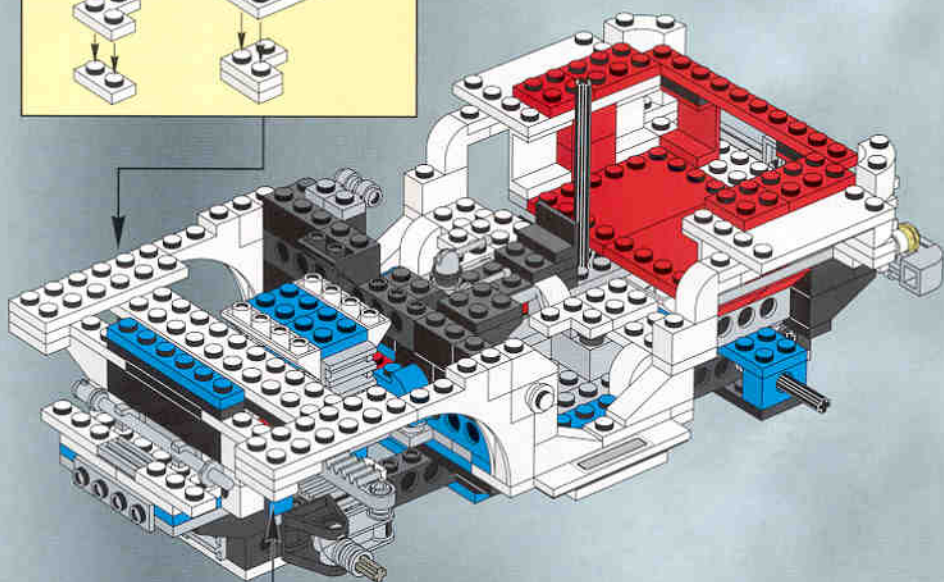
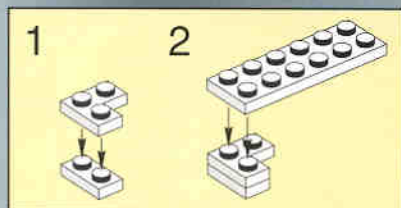

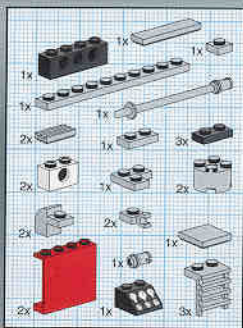

33

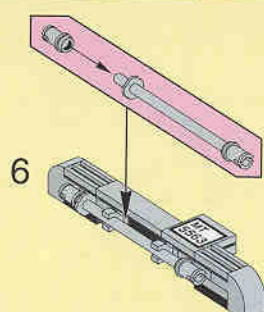
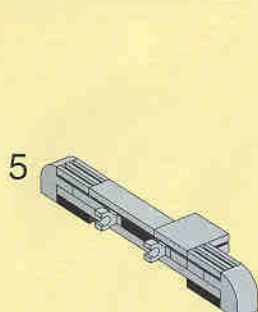
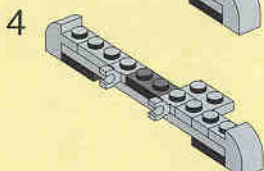
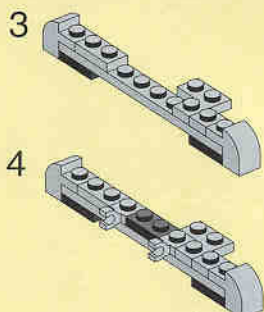
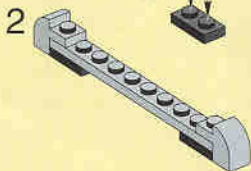
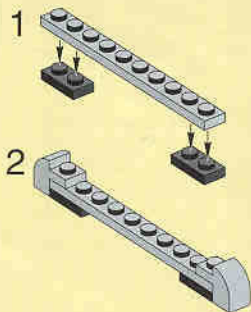
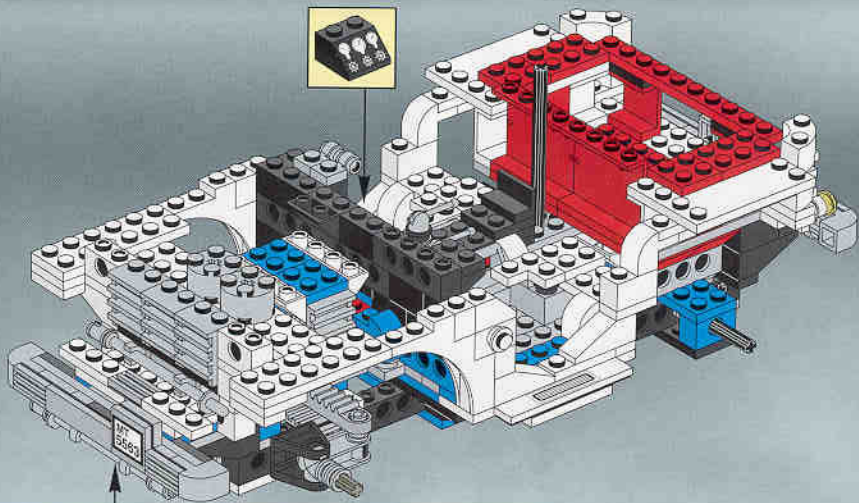

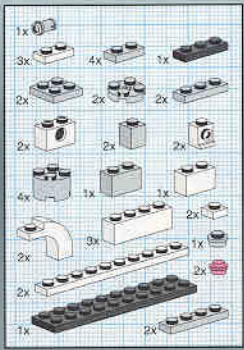

34

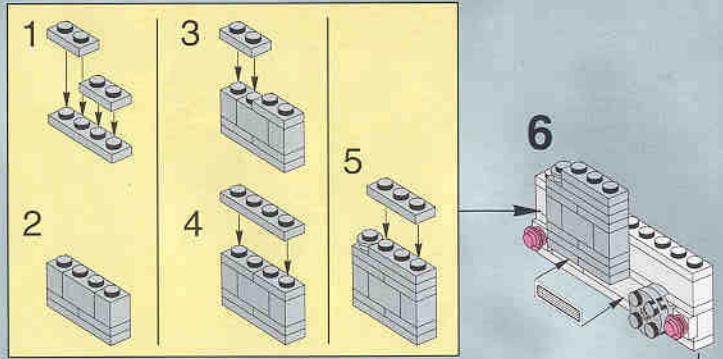
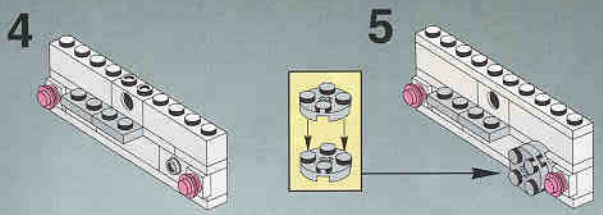
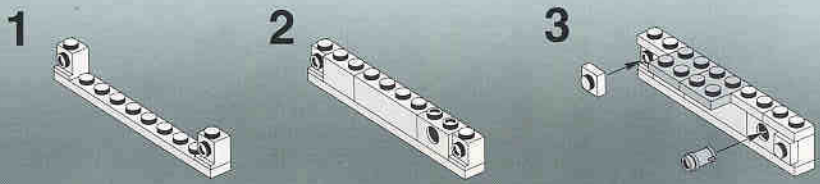

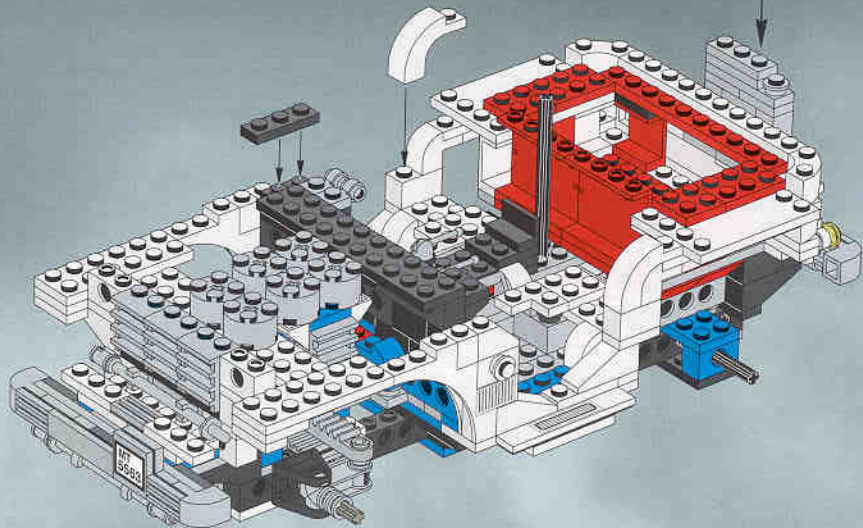

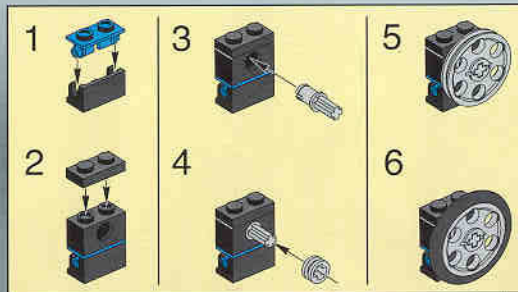
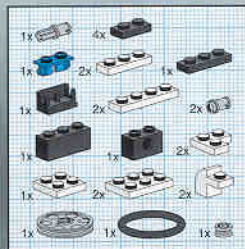

35

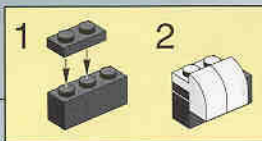
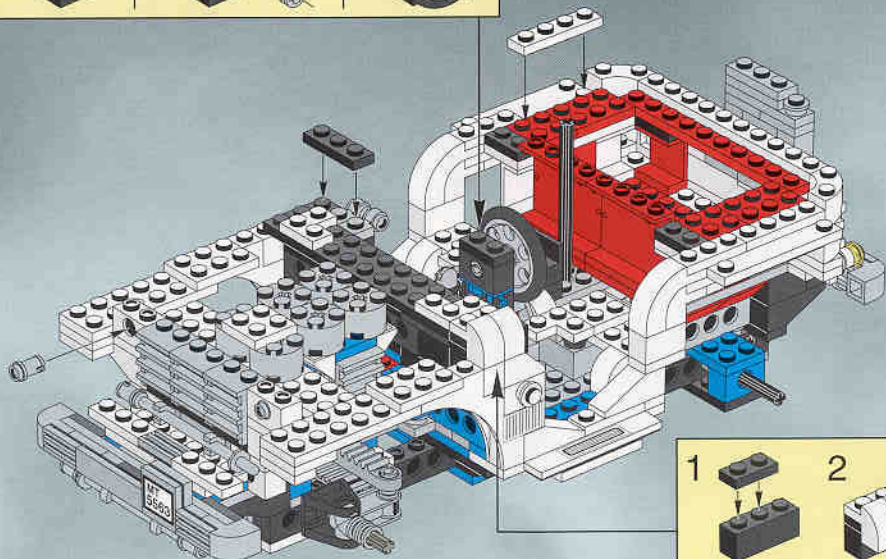

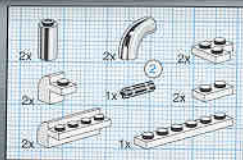

36

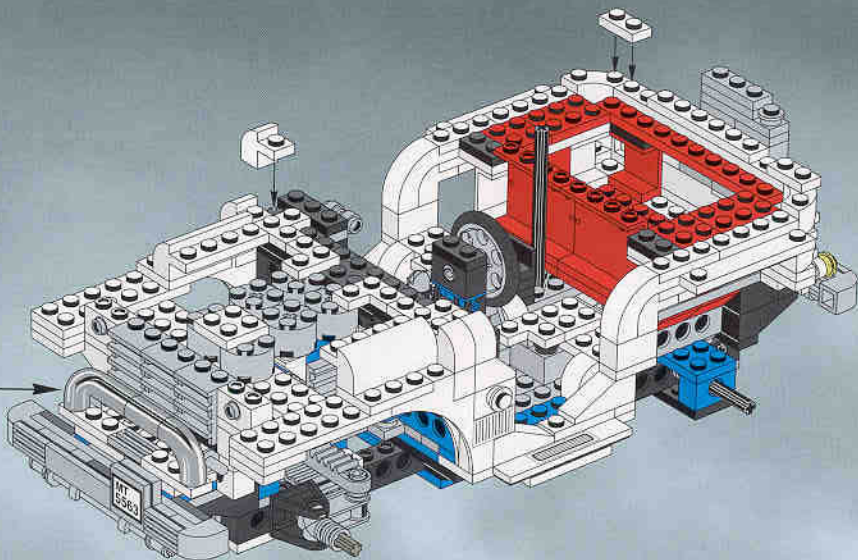
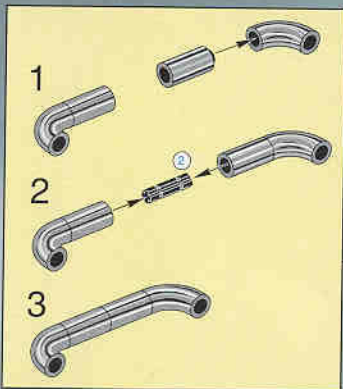

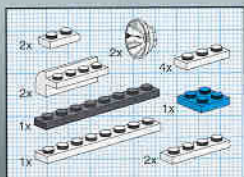

37

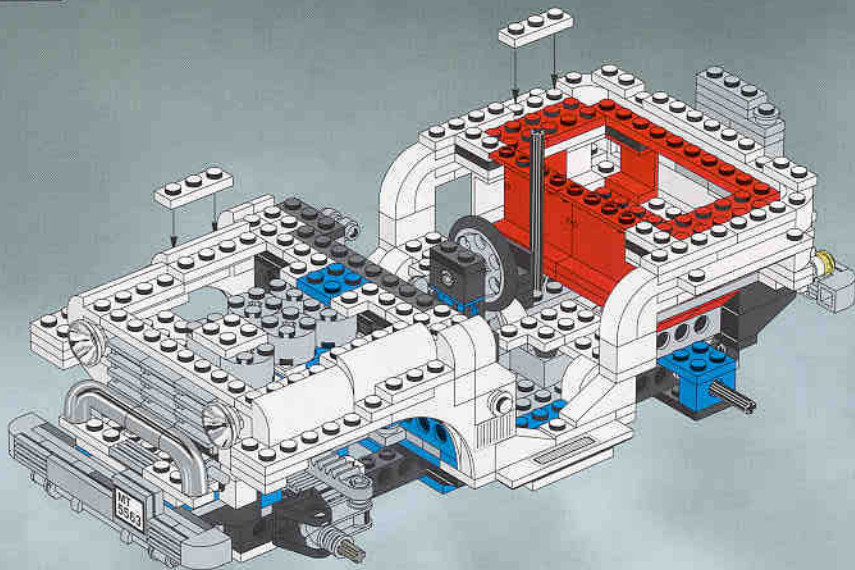

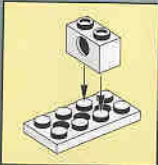
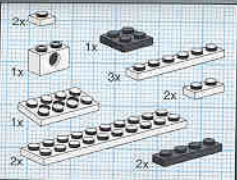

38

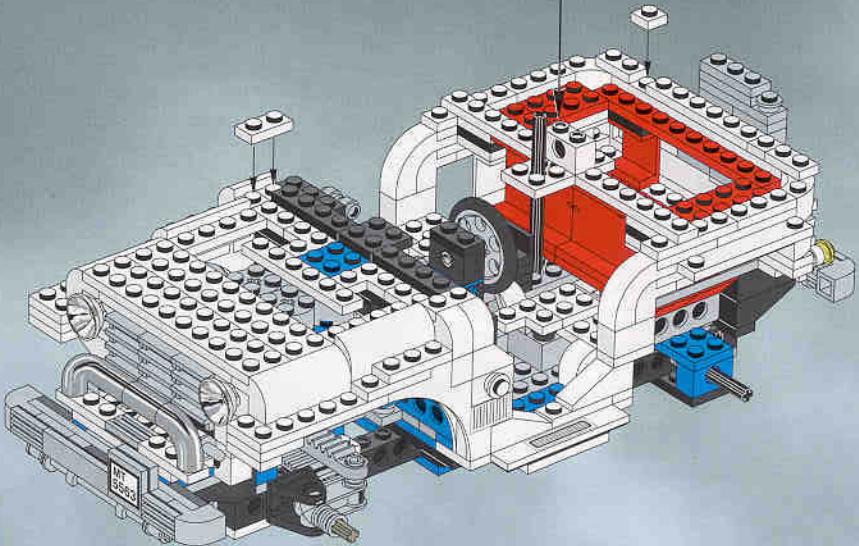

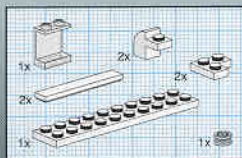

39

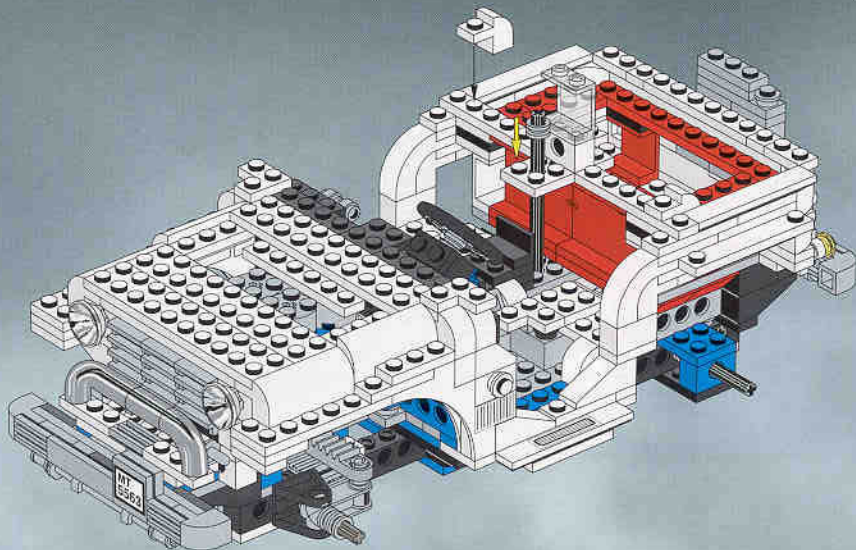

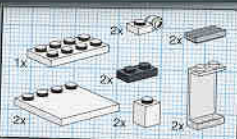

40

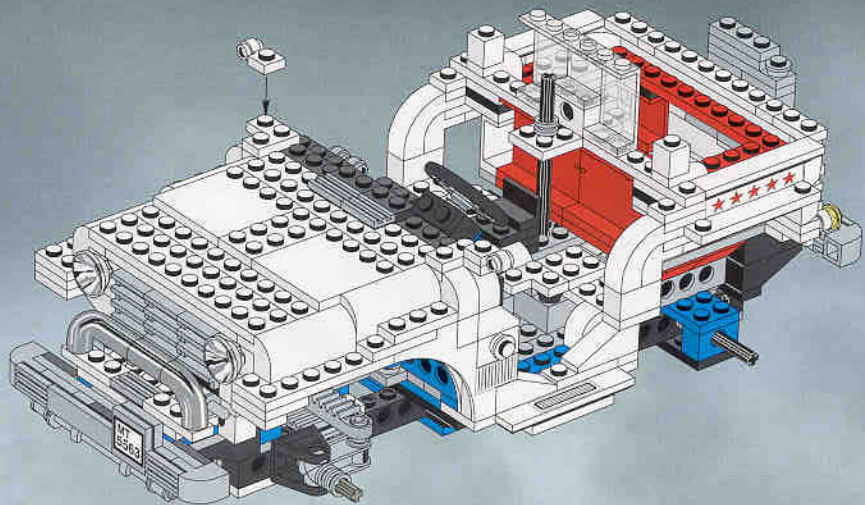

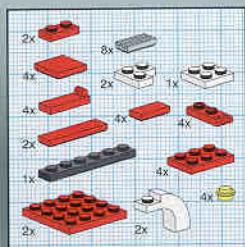

41

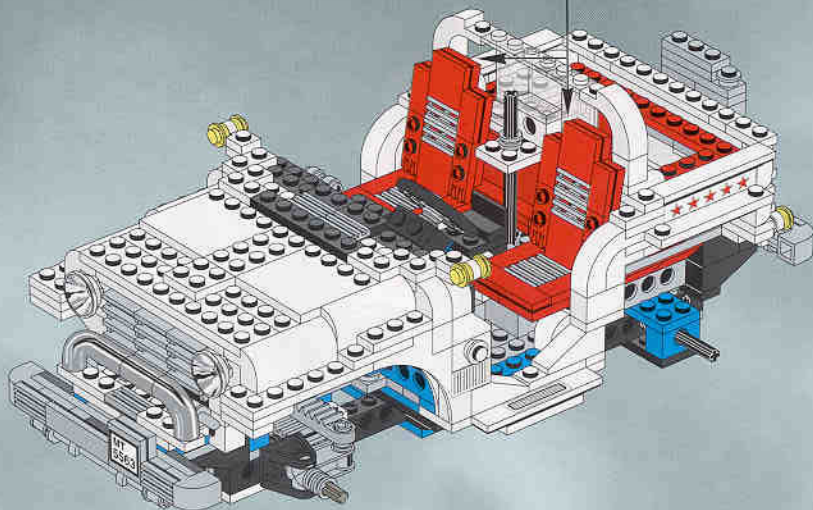
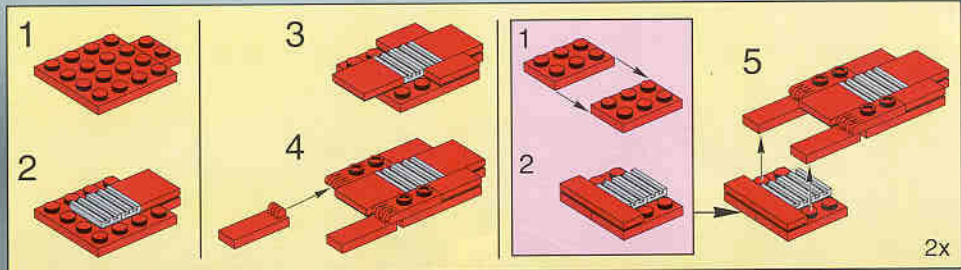

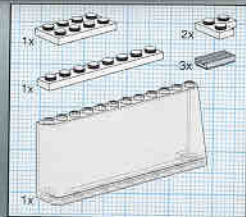

42

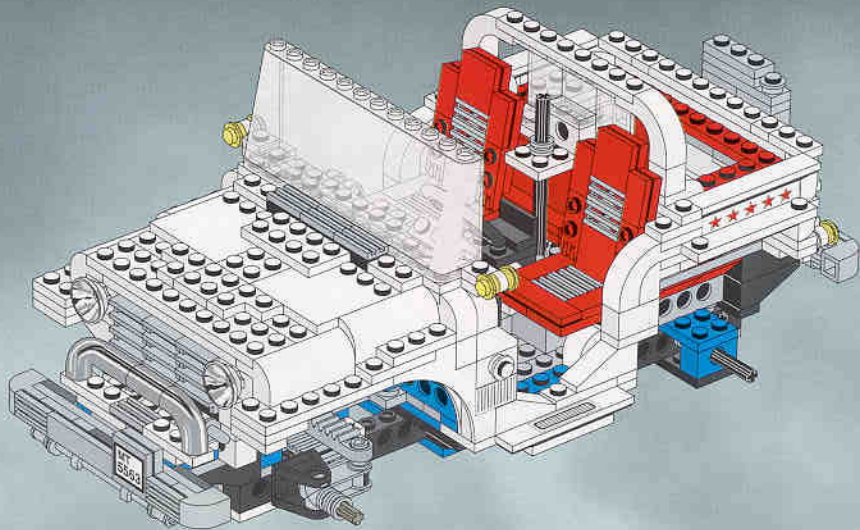

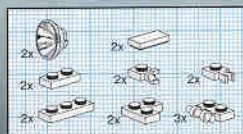

43

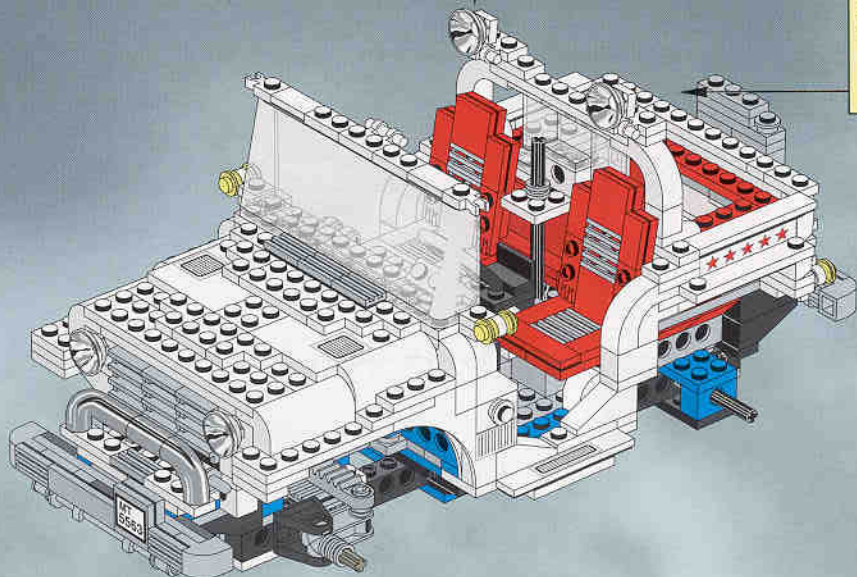
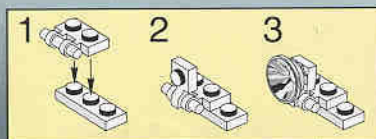

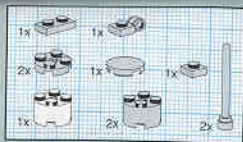

44

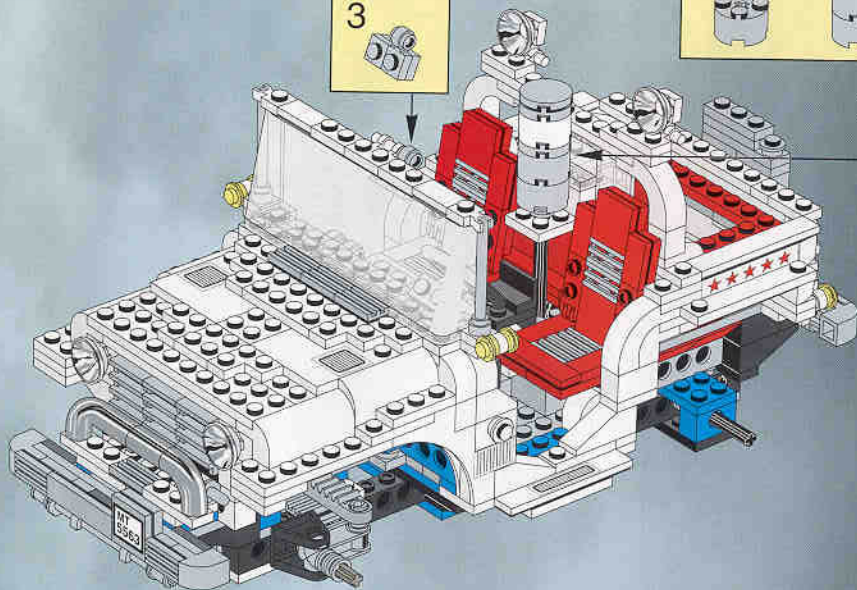
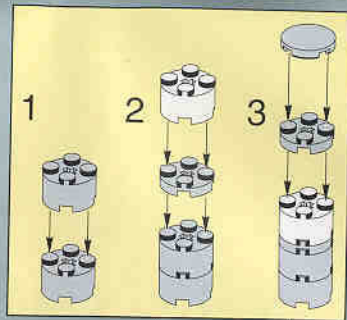
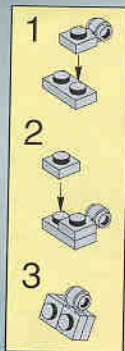

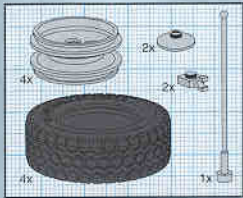

45

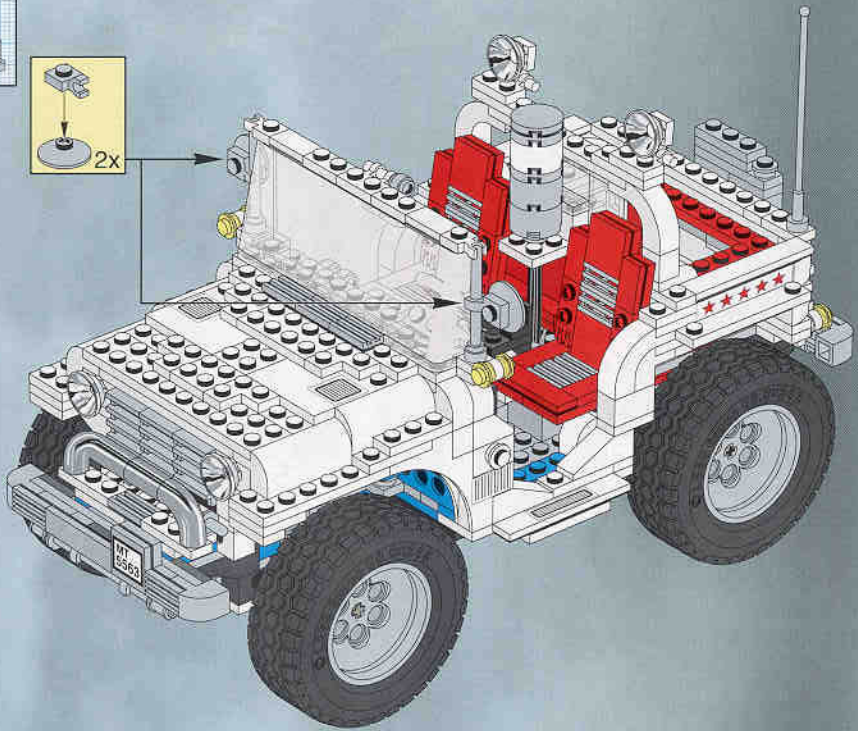

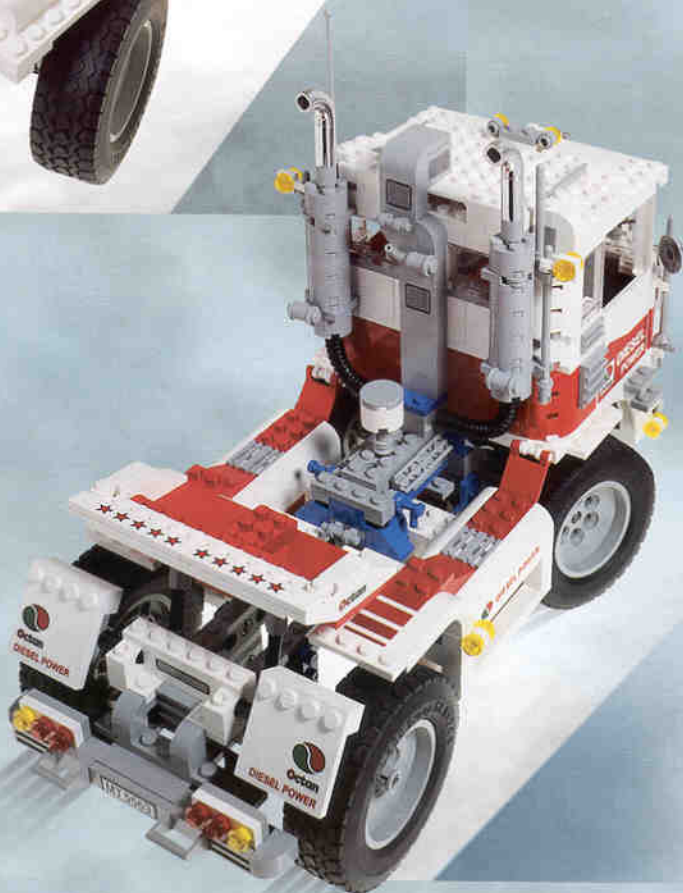

1



2



DIESEL POWER 

 DIESEL POWER

DIESEL
POWER



DIESEL
POWER

 DIESEL
POWER 

 Octan

MT
5563

MT
5563

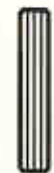

Octan



Octan



Octan

DIESEL POWER



Octan

DIESEL POWER

