

LEGO SYSTEM™

MODEL TEAM 5563

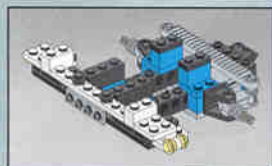

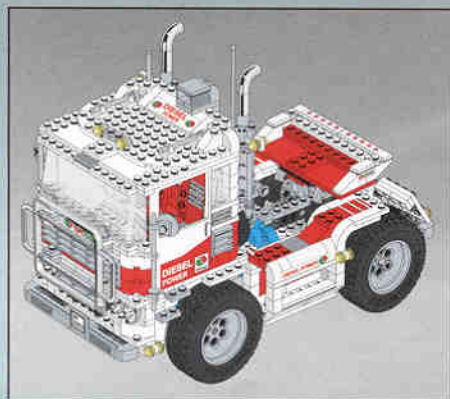
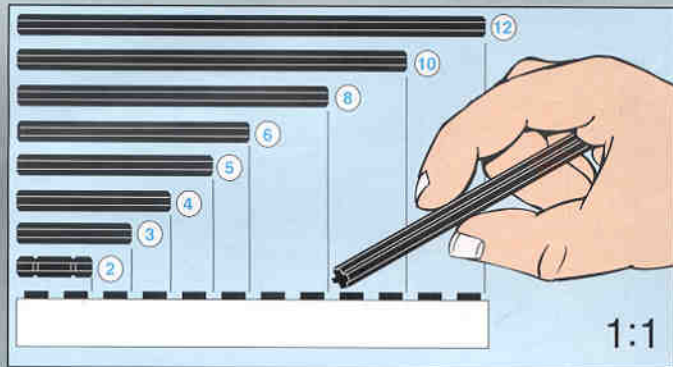

1

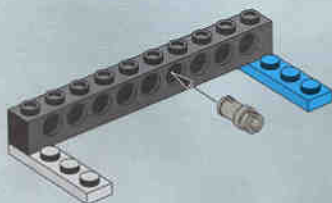



2

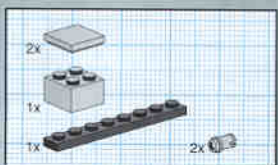
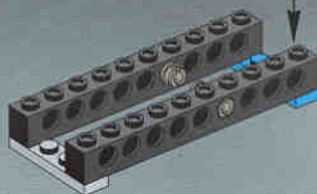
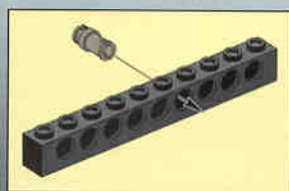

3

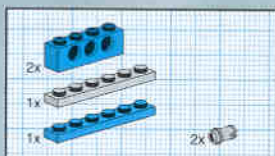
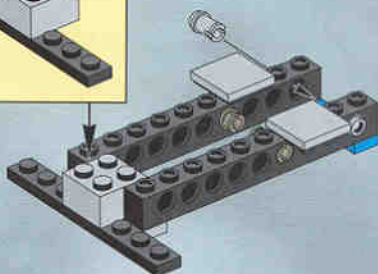
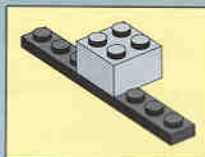

4

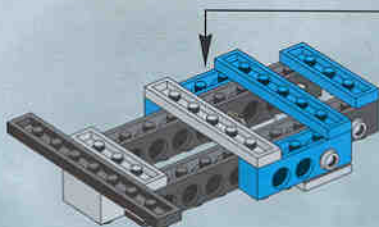
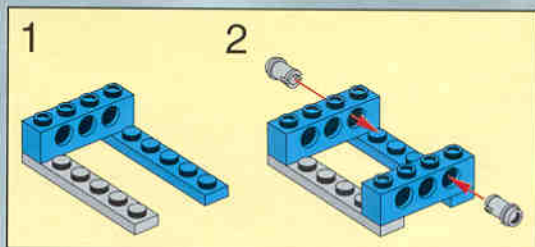

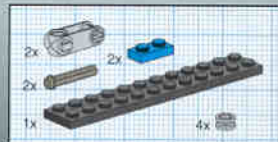

8

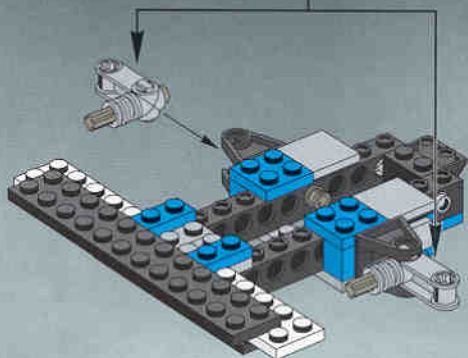
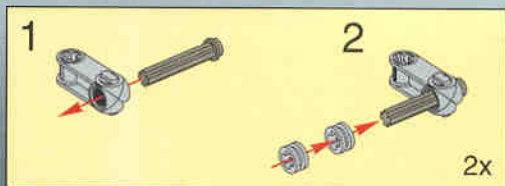

9

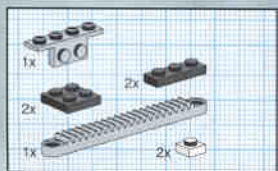
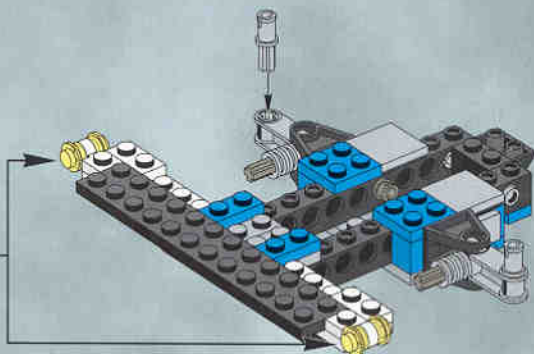
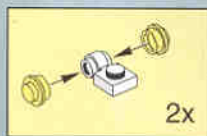

10

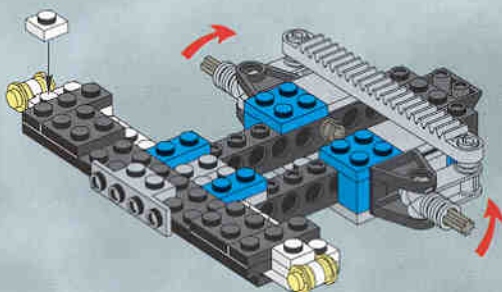



5

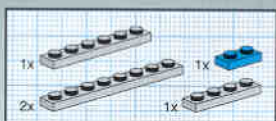
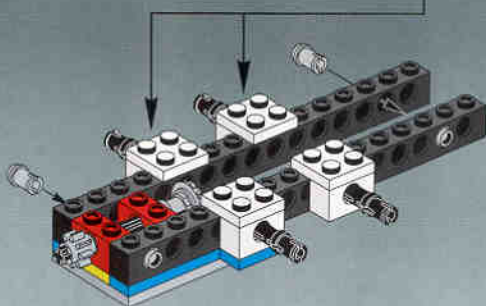

6

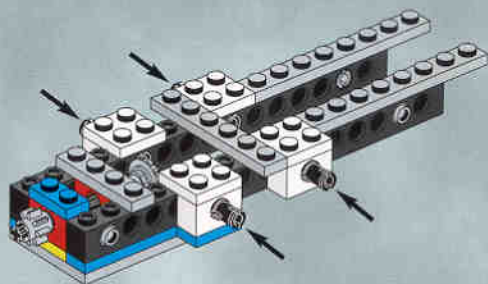

7

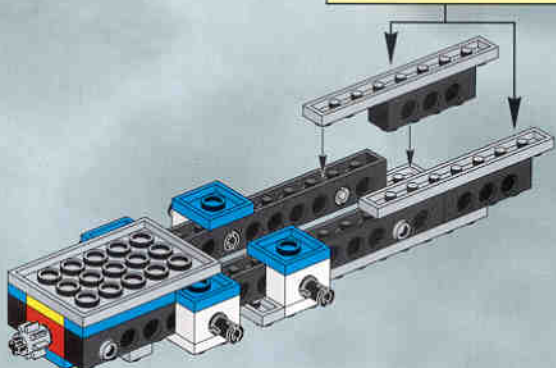
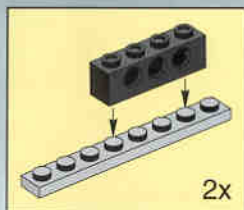

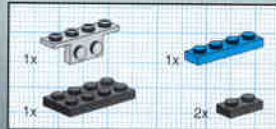

8

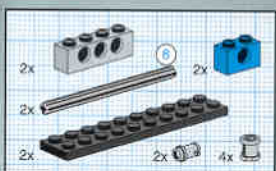
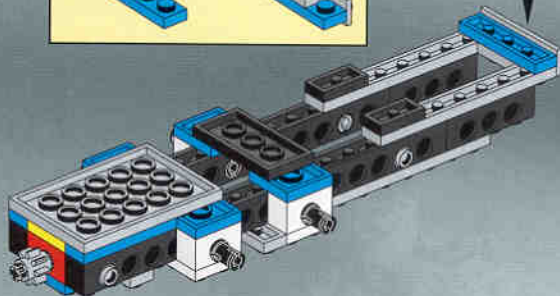
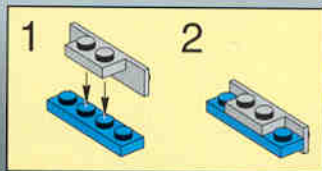

9

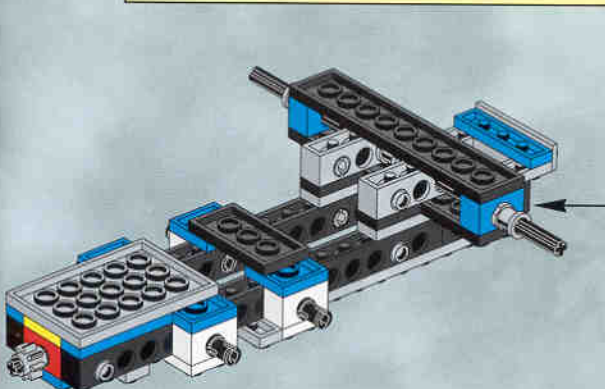
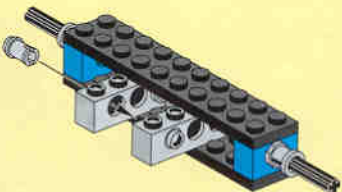
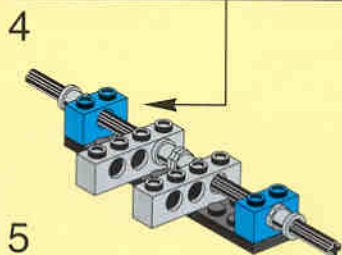
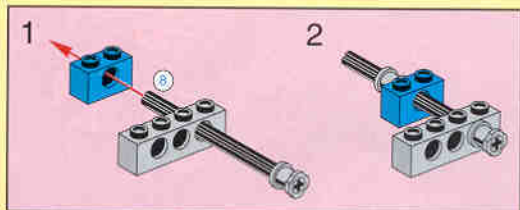
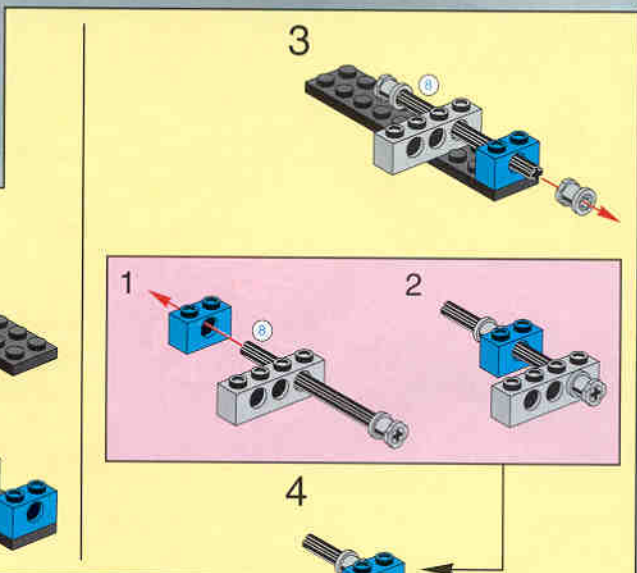
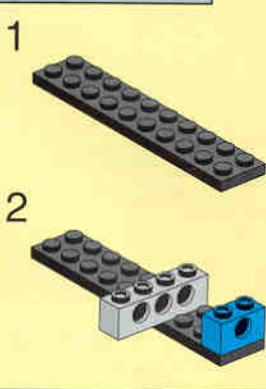

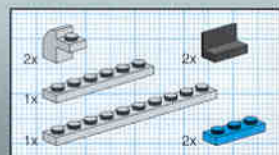

10

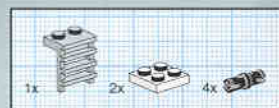
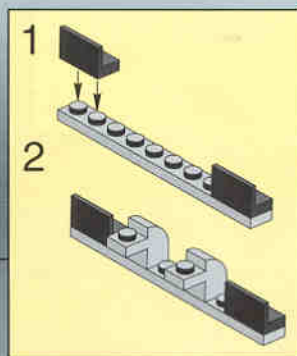
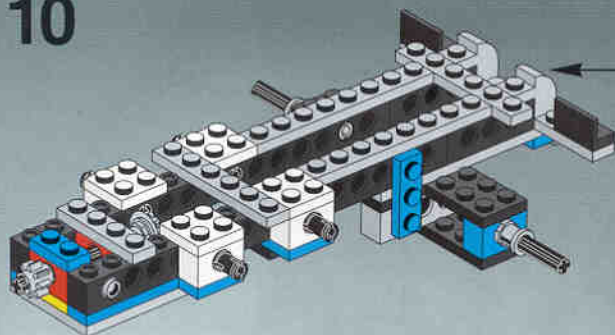

11

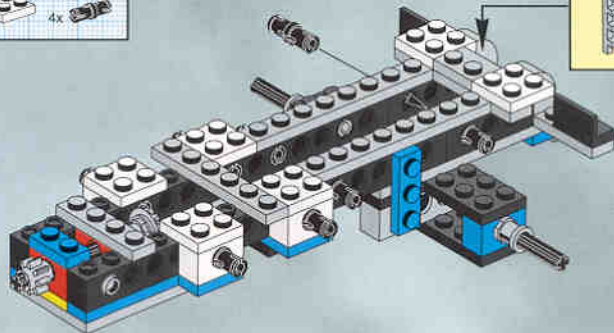

12

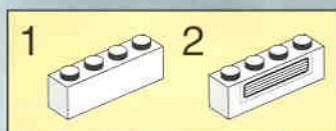
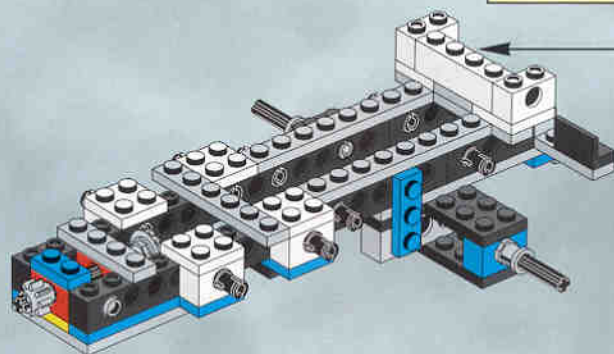

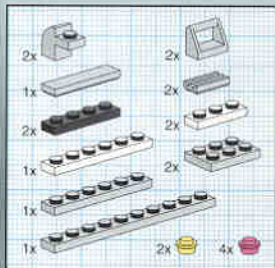

13

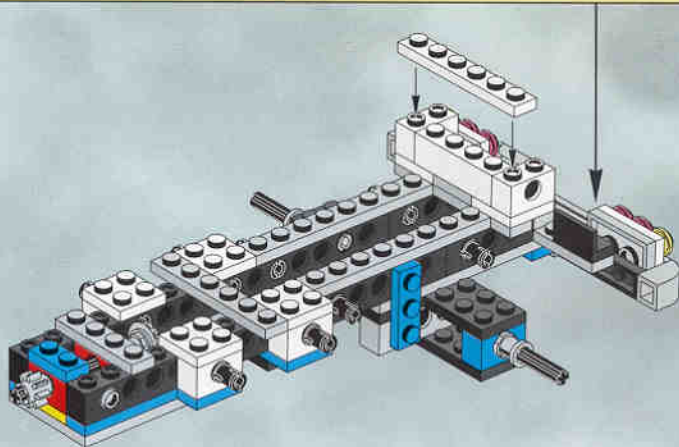
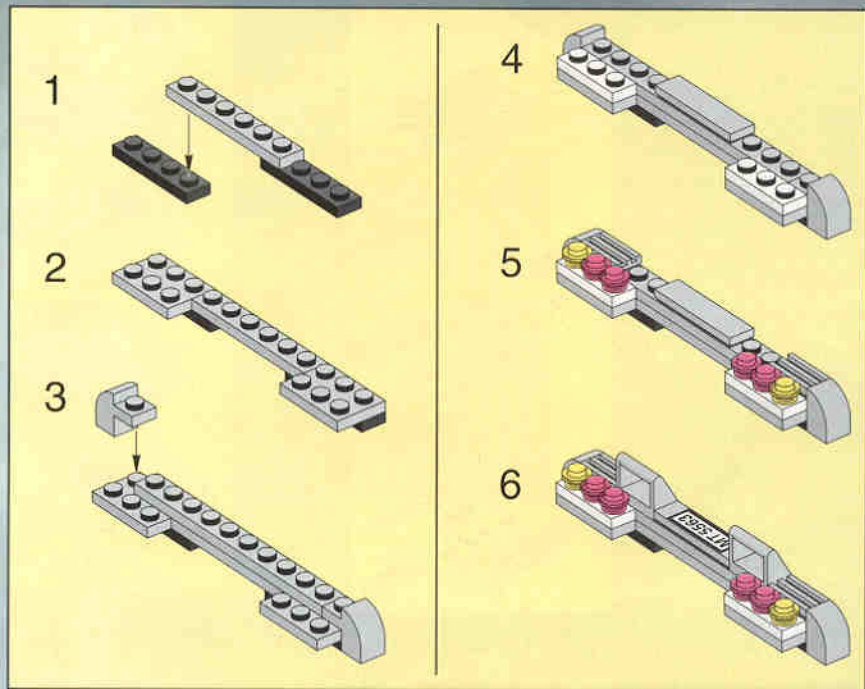

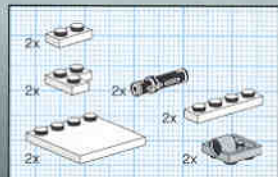

14

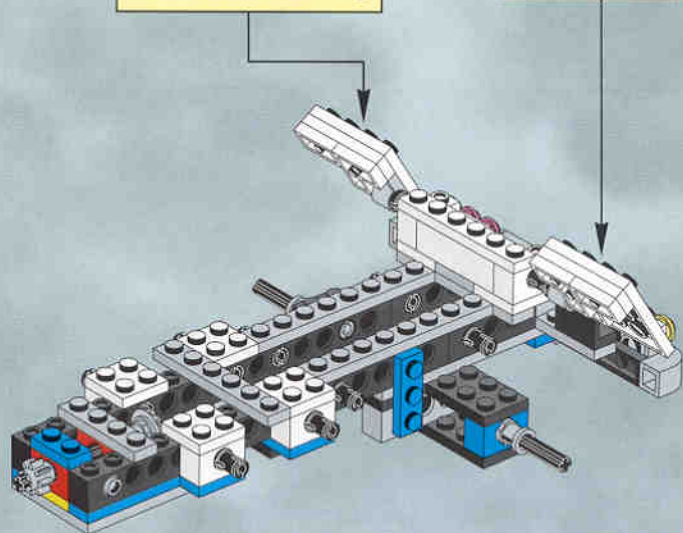
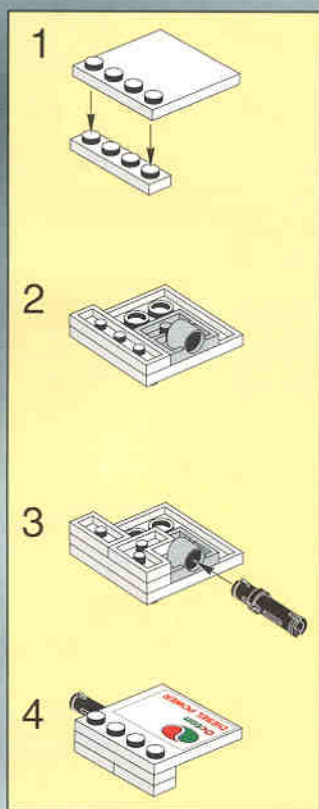
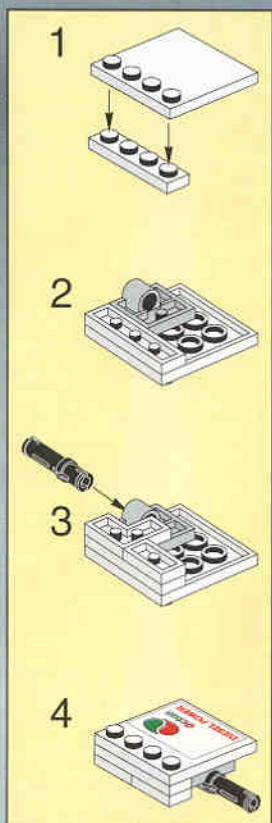



15

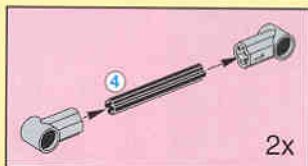
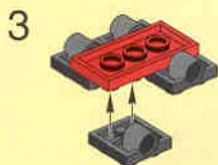

5

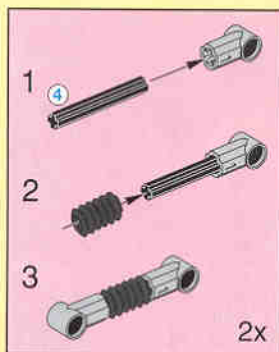
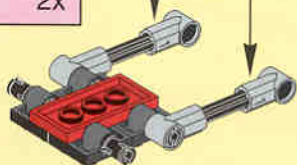

6

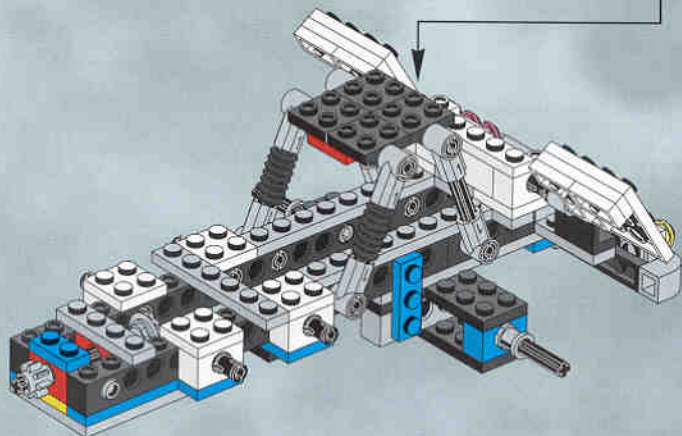
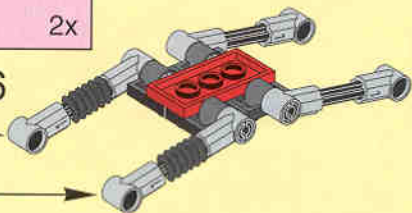

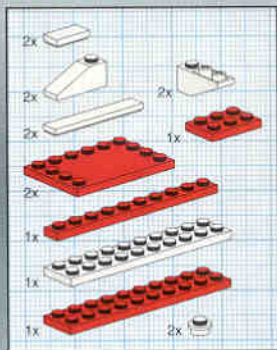

16

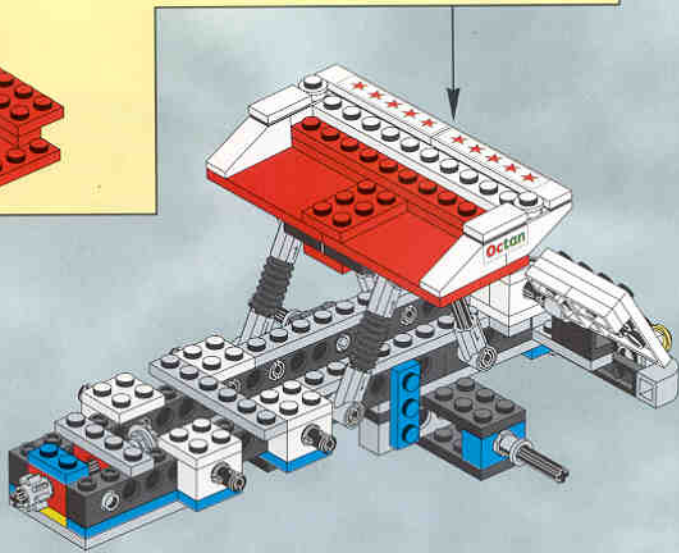
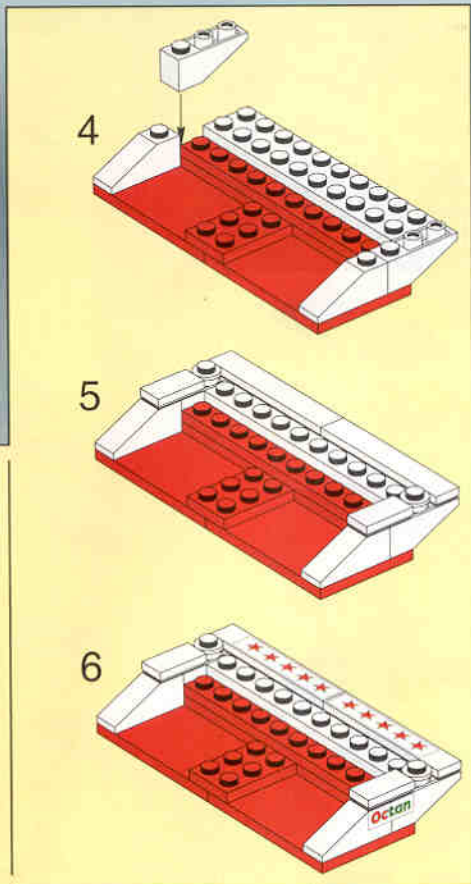
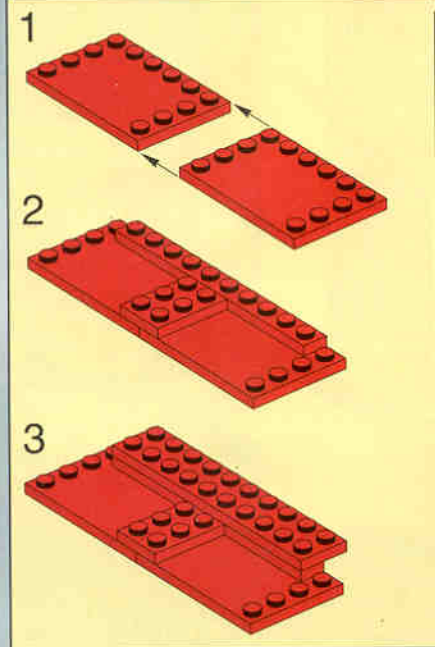

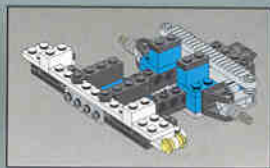

+

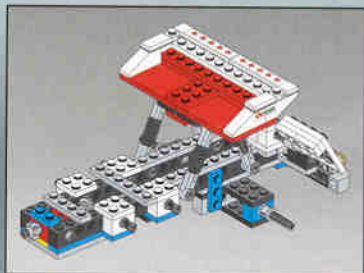

17

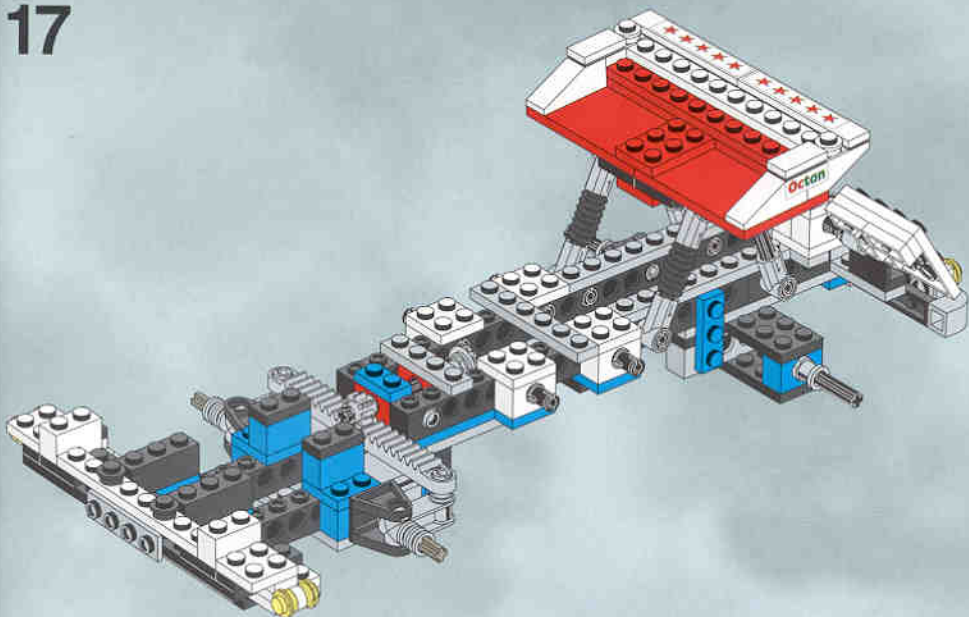

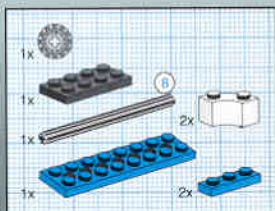

18

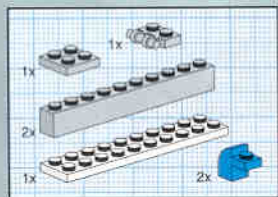
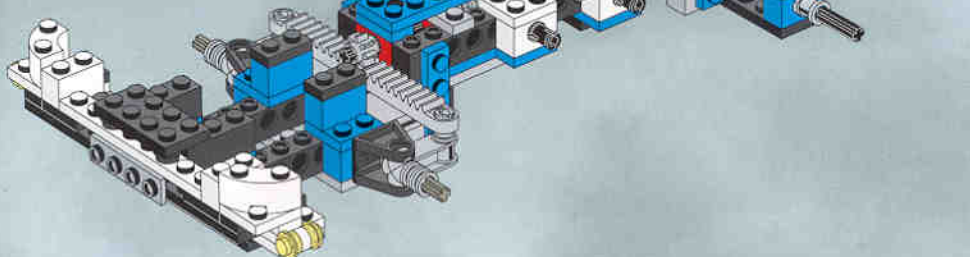
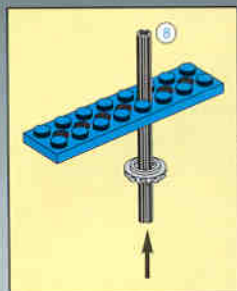

19

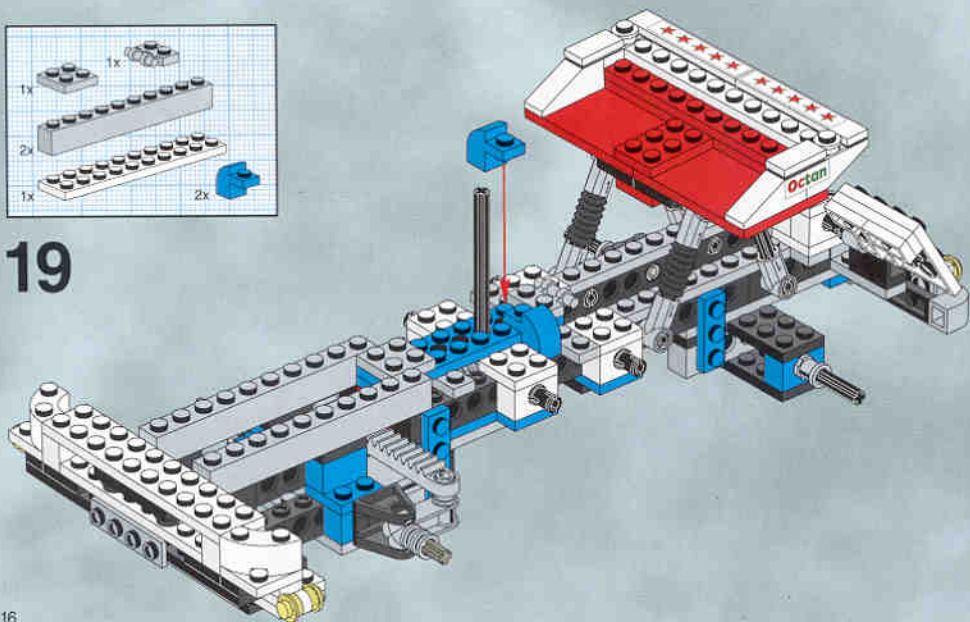

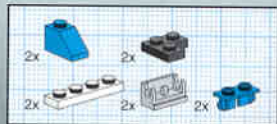

20

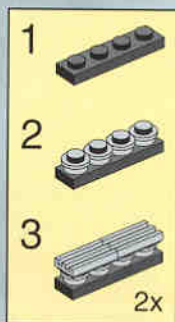
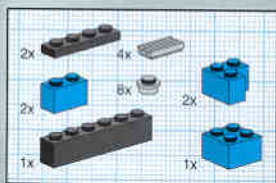
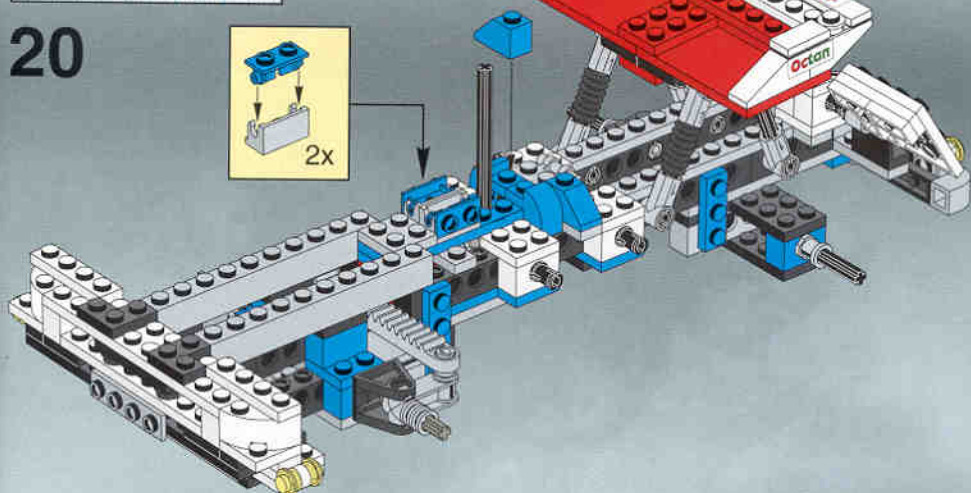

21

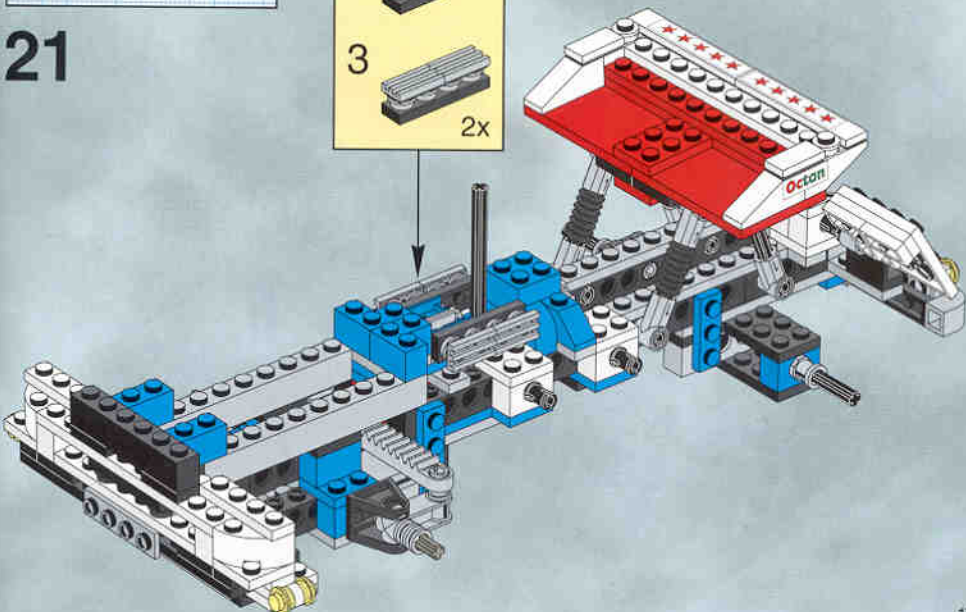



22

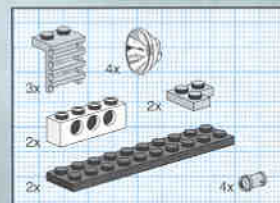
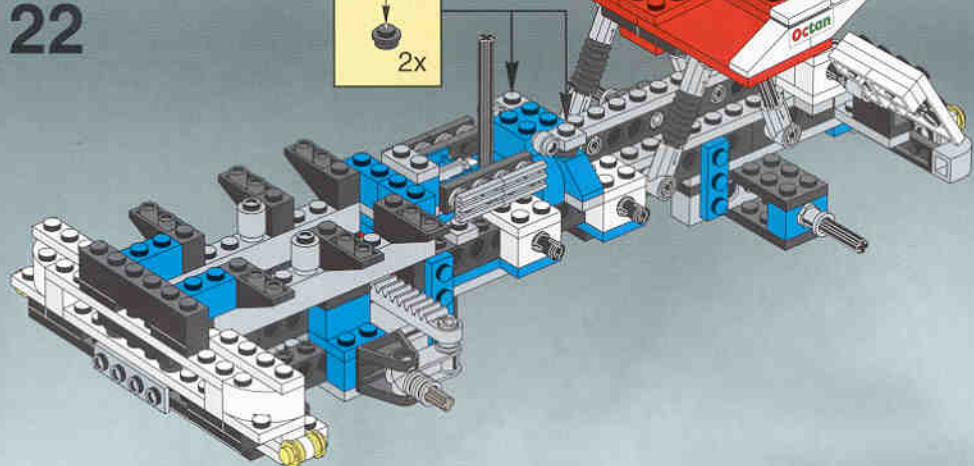

23

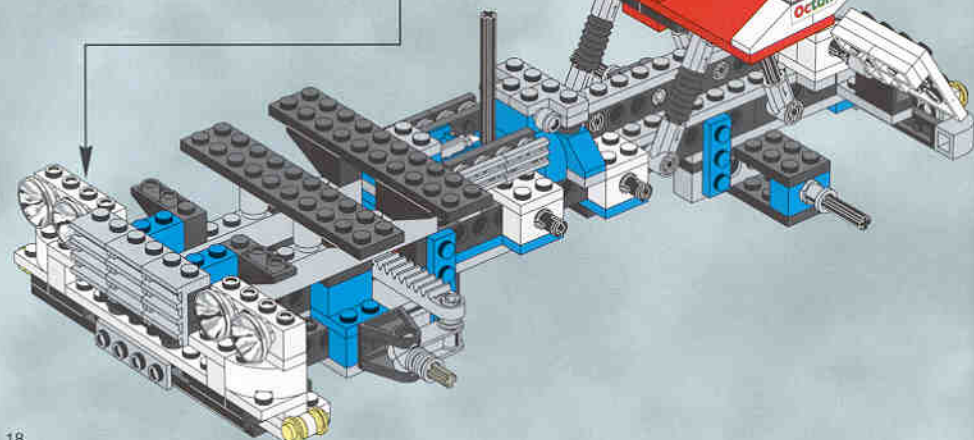
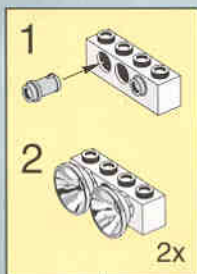

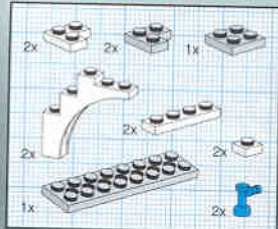

24

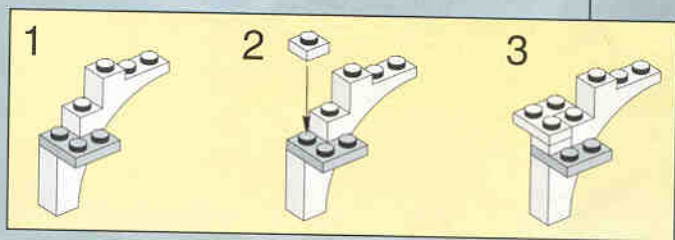
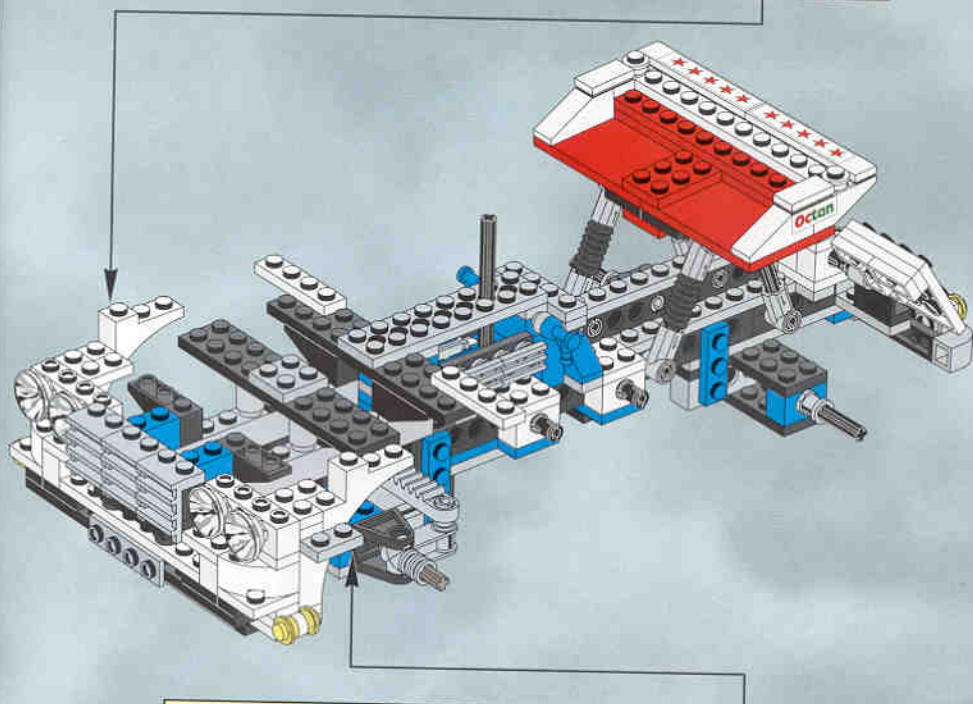
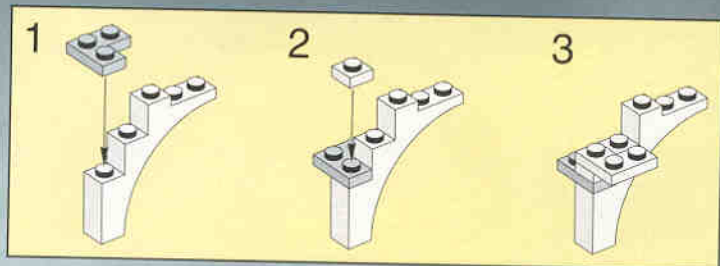

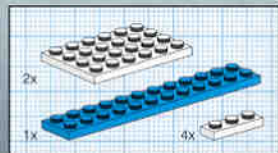

25

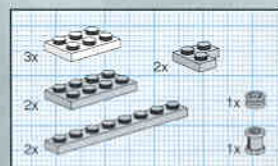
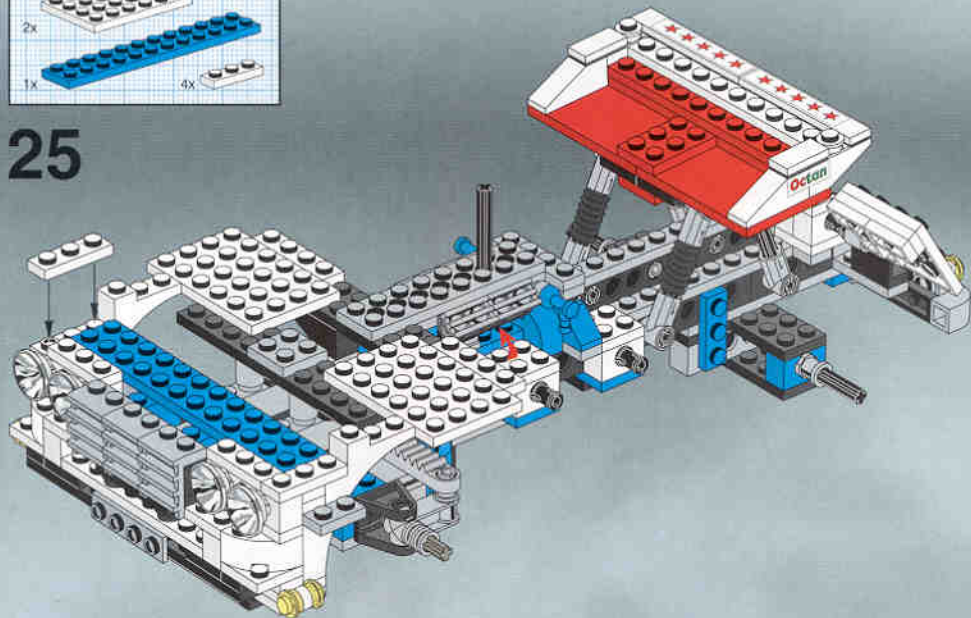

26

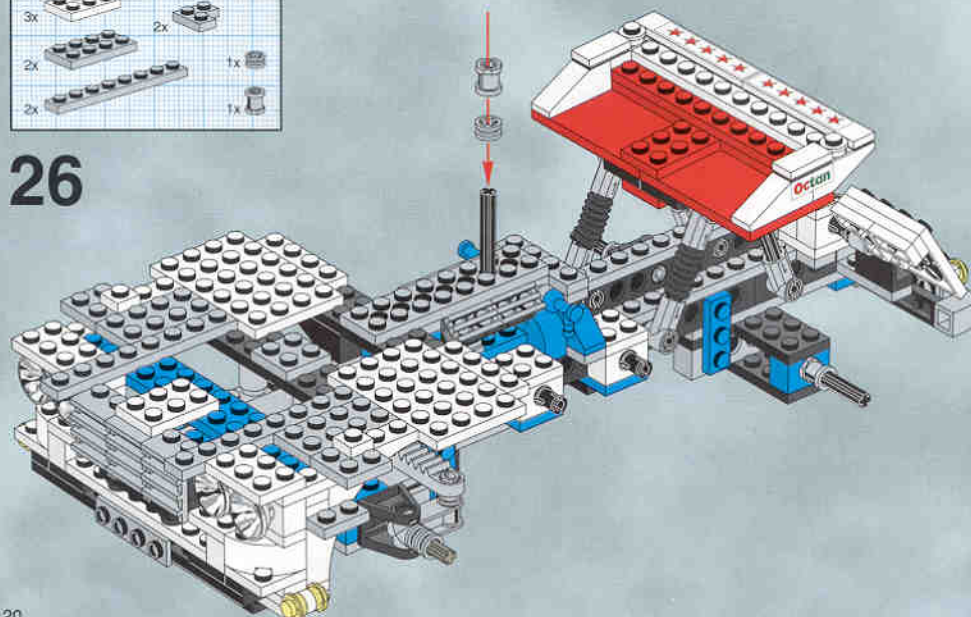

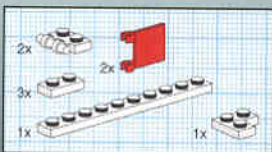

27

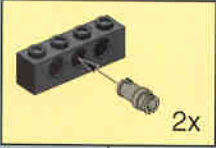
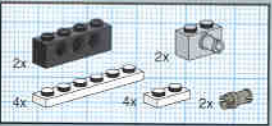
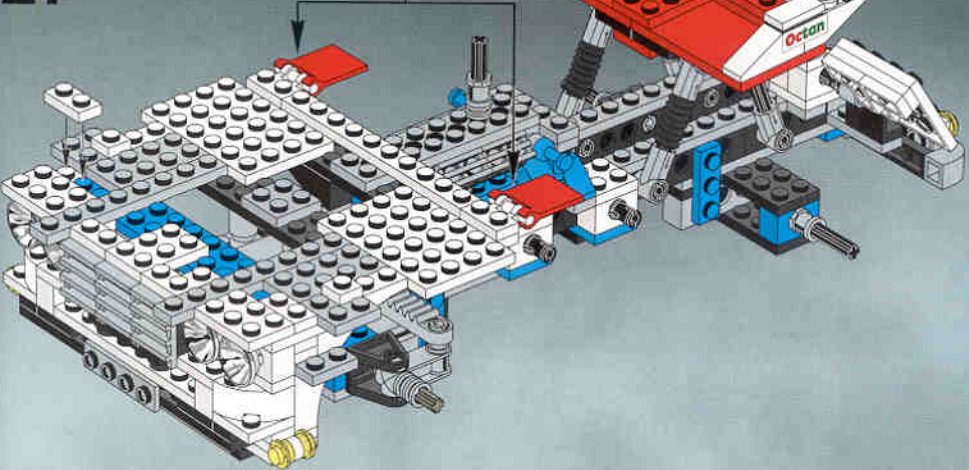

28

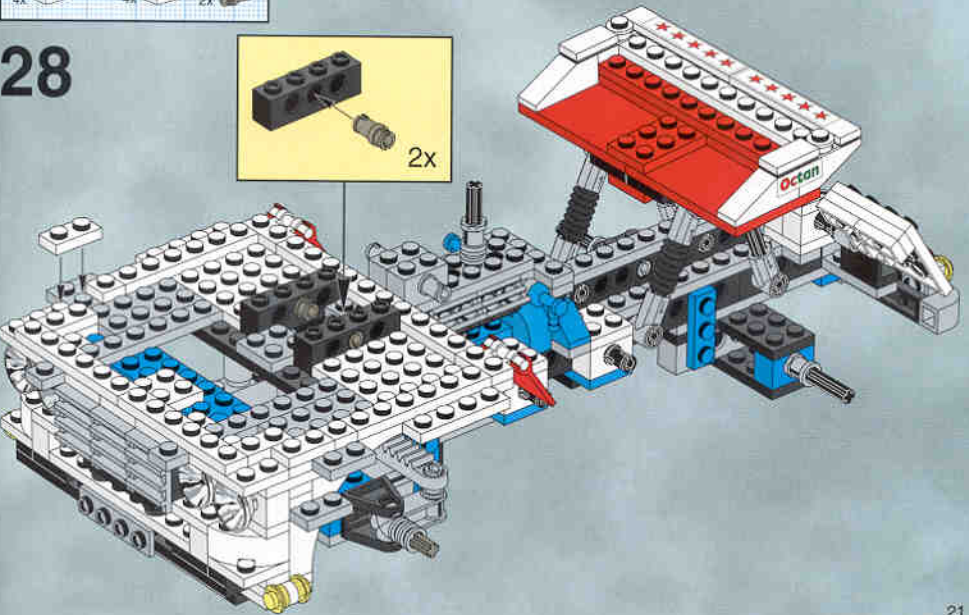

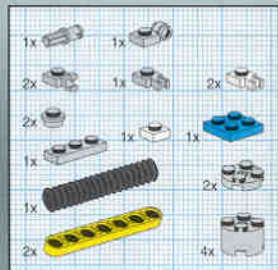

29

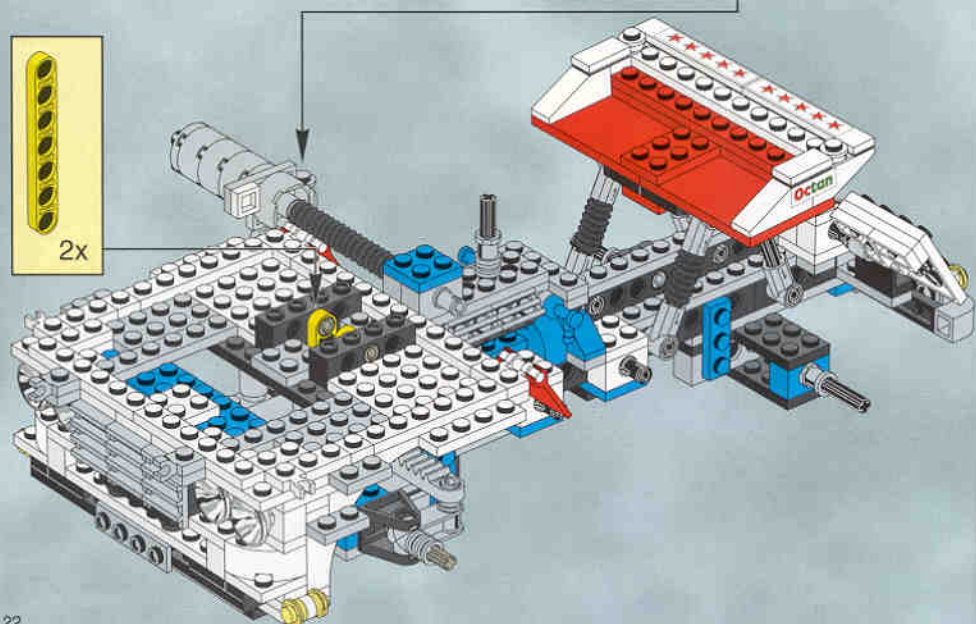
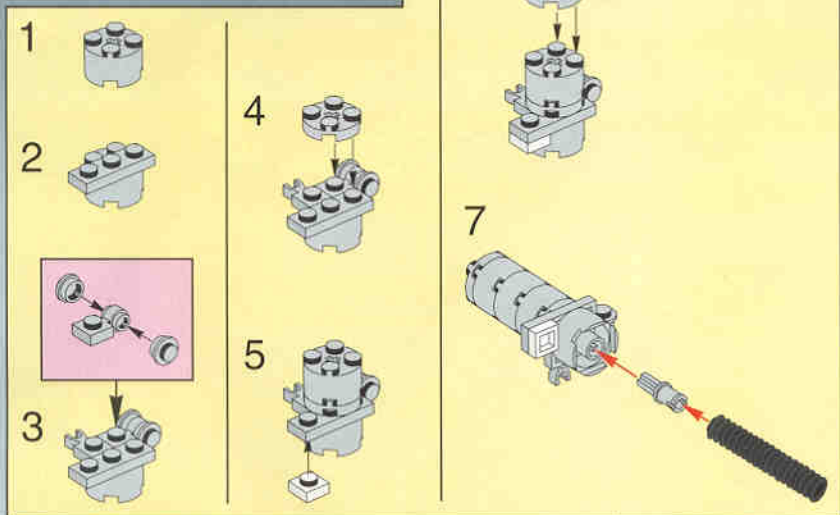

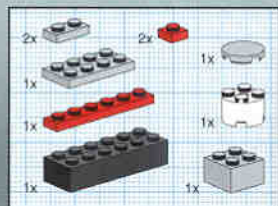

31

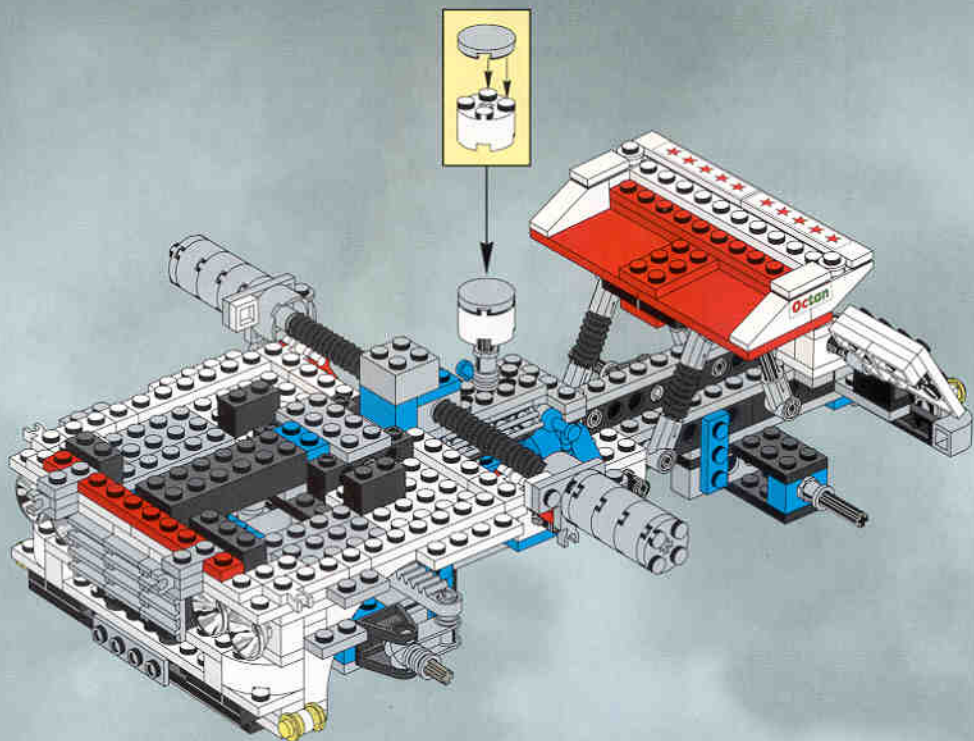

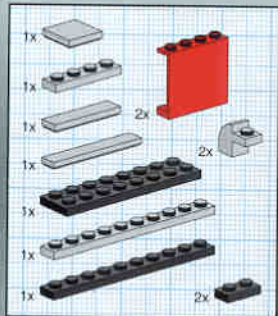

32

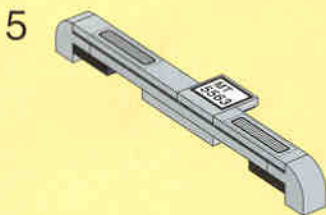
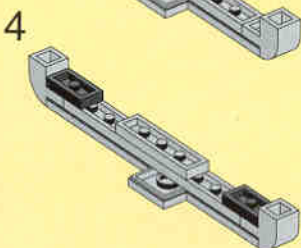
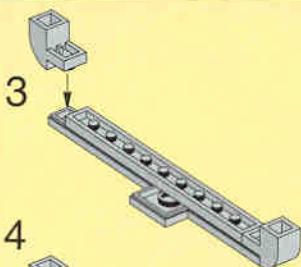
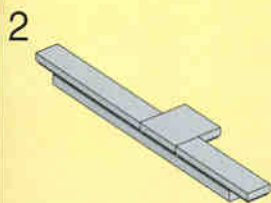
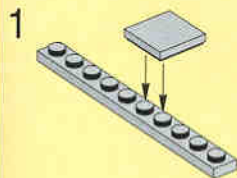
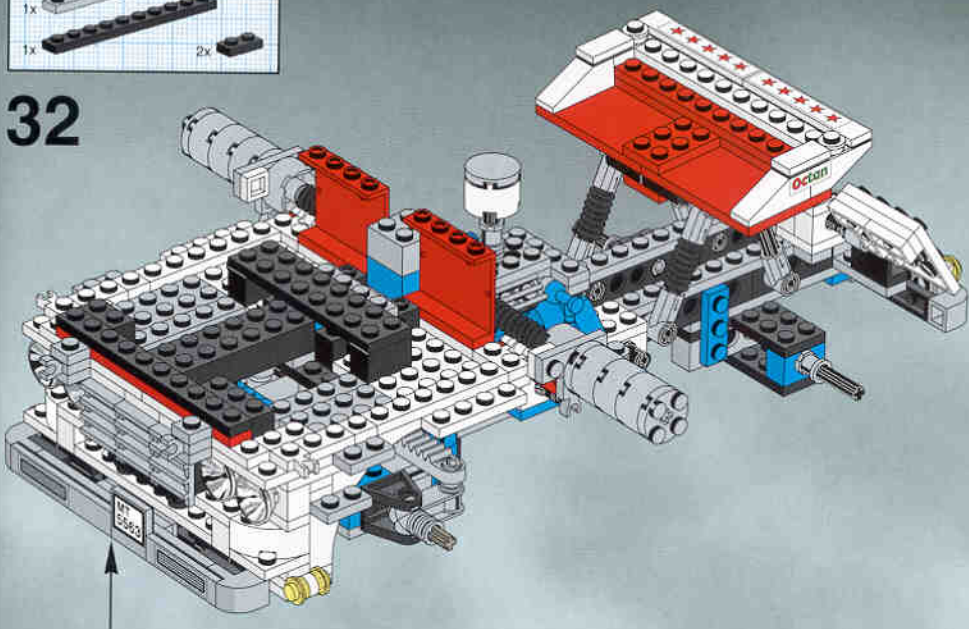

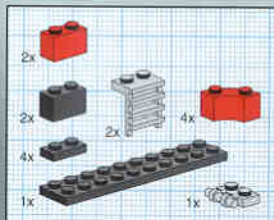

34

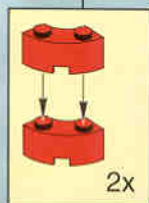
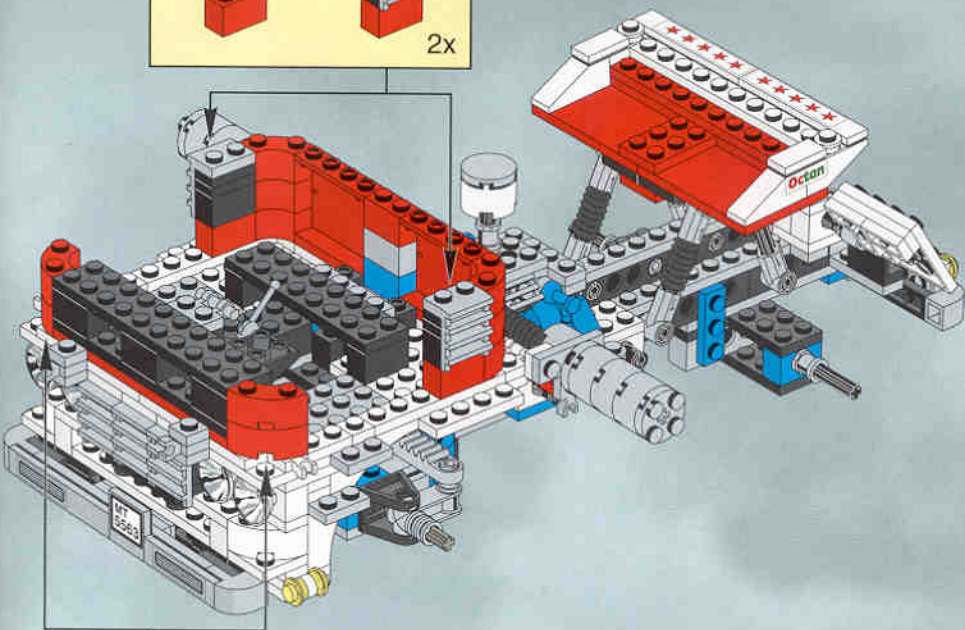
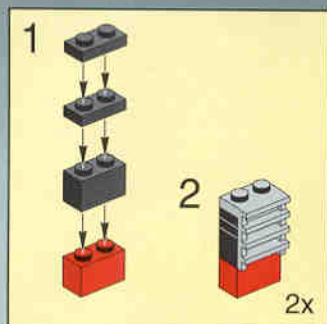



35

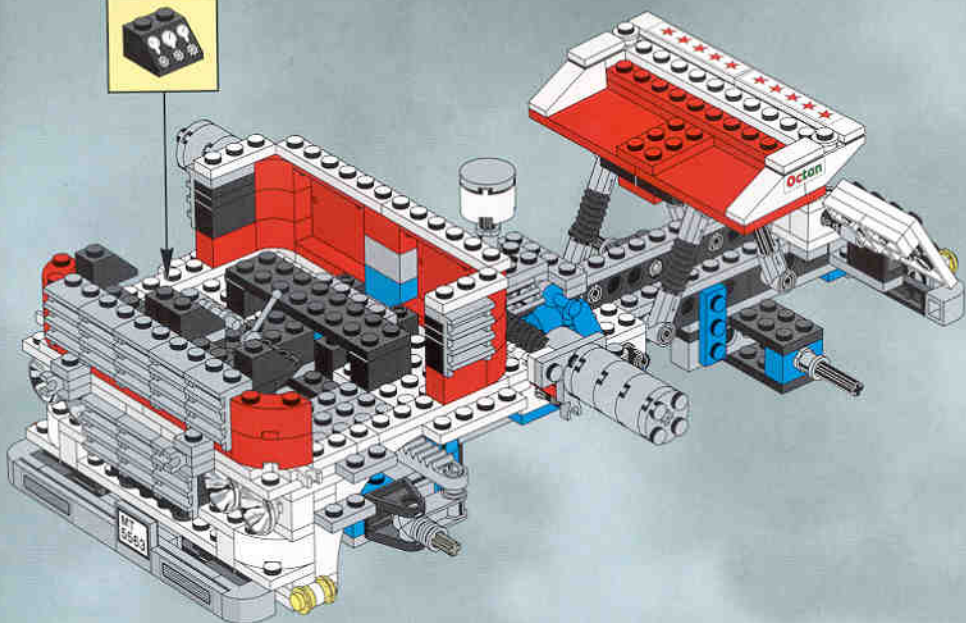



36

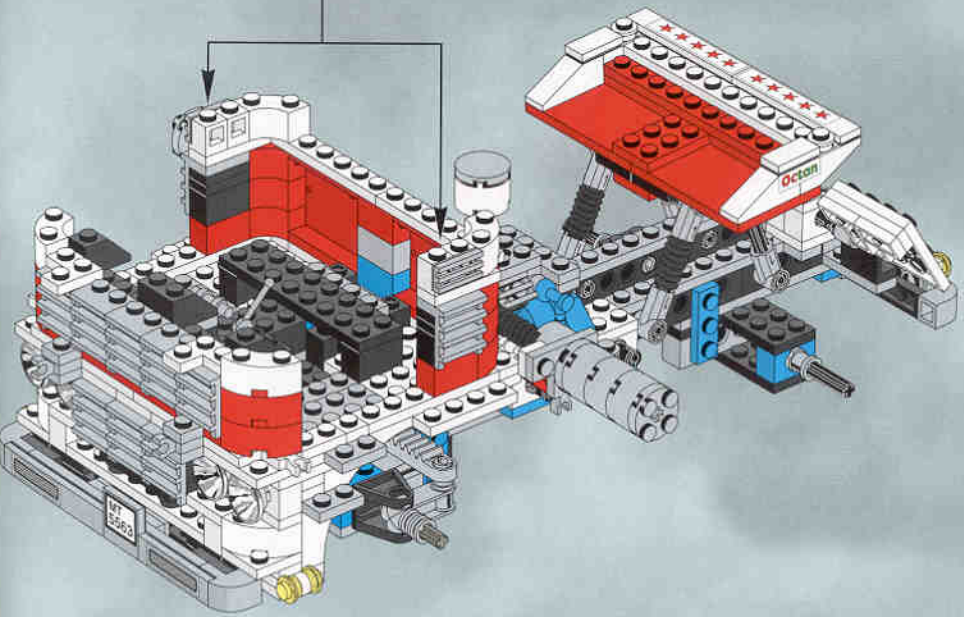
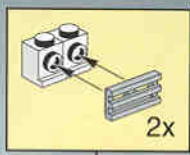

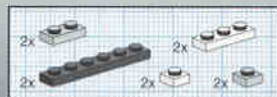

37

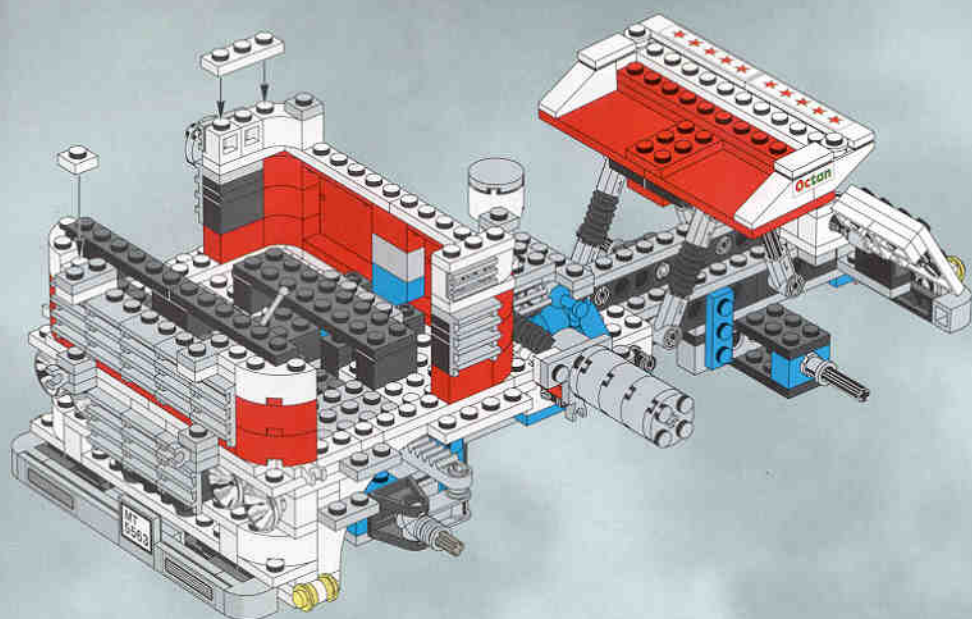

38

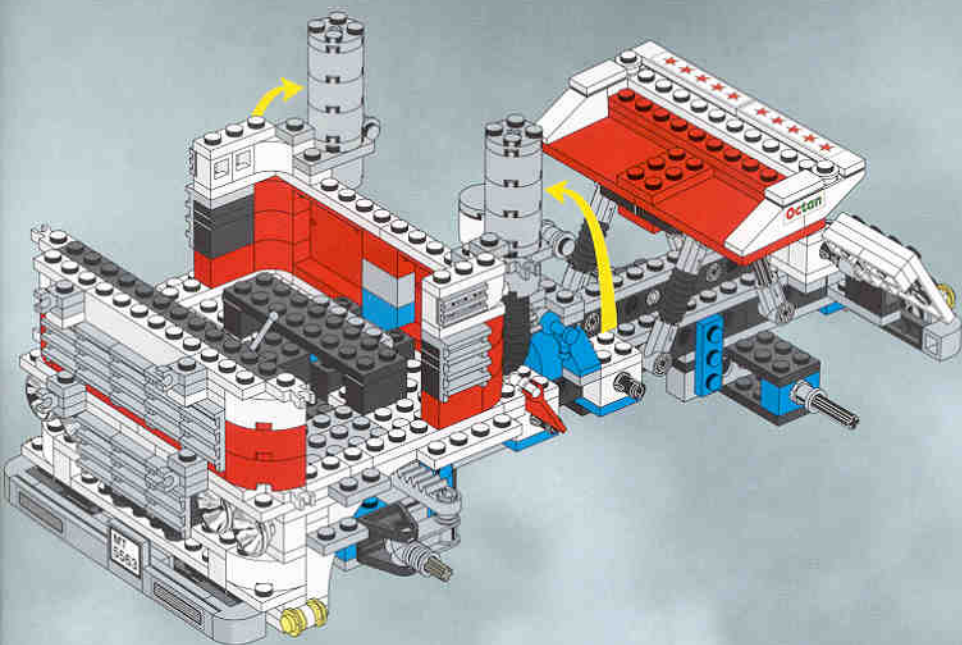
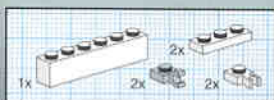



39

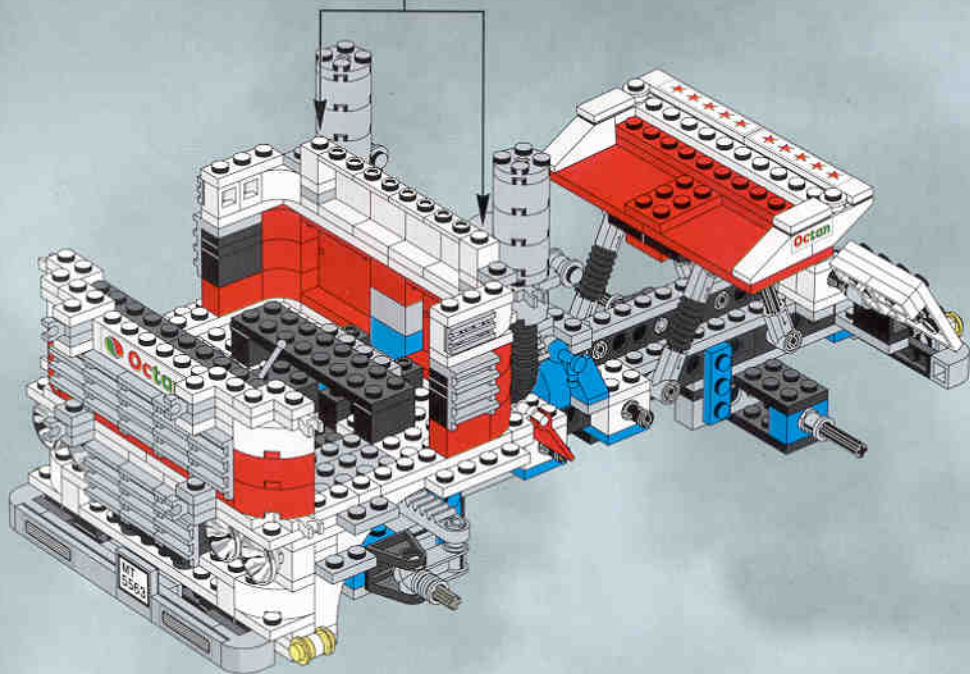
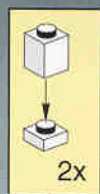

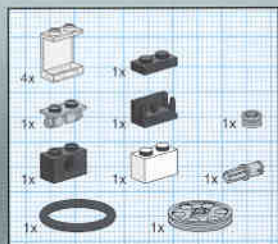

41

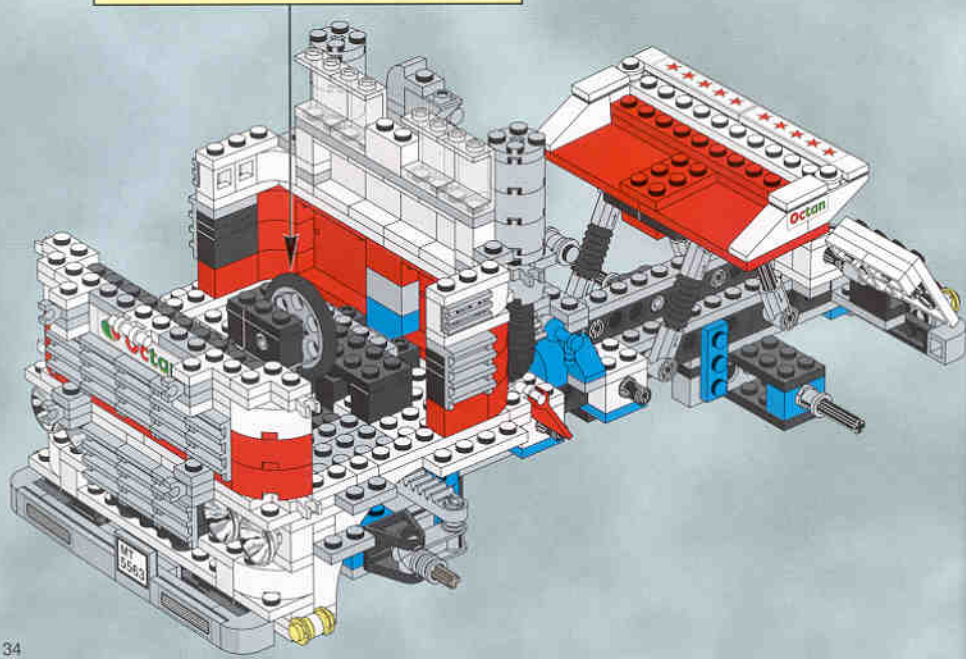
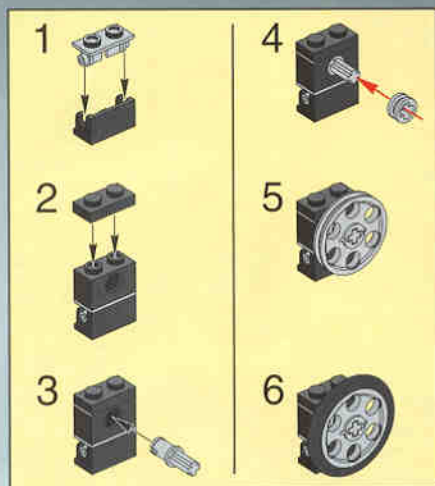

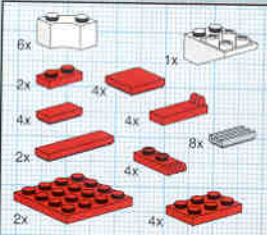

42

1. Start with a 4x4 red Technic plate.

2. Attach a 1x2 grey Technic plate to the top edge of the 4x4 red plate.

3. Attach a 1x2 red Technic plate to the top edge of the 1x2 grey plate.

4. Attach a 1x2 red Technic plate to the top edge of the 1x2 red plate.

5. Attach a 1x2 red Technic plate to the top edge of the 1x2 red plate.

2x

Main assembly diagram showing the sub-assembly from step 42 being attached to a larger white and red LEGO Technic model. The sub-assembly is being attached to the top of the model, which features a red and white canopy with the word "Octan" on it. The sub-assembly is being attached to the top of the model, which features a red and white canopy with the word "Octan" on it.

2x

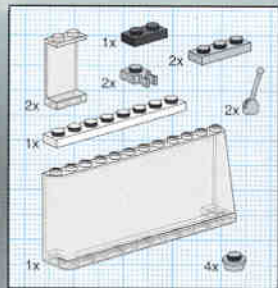

43

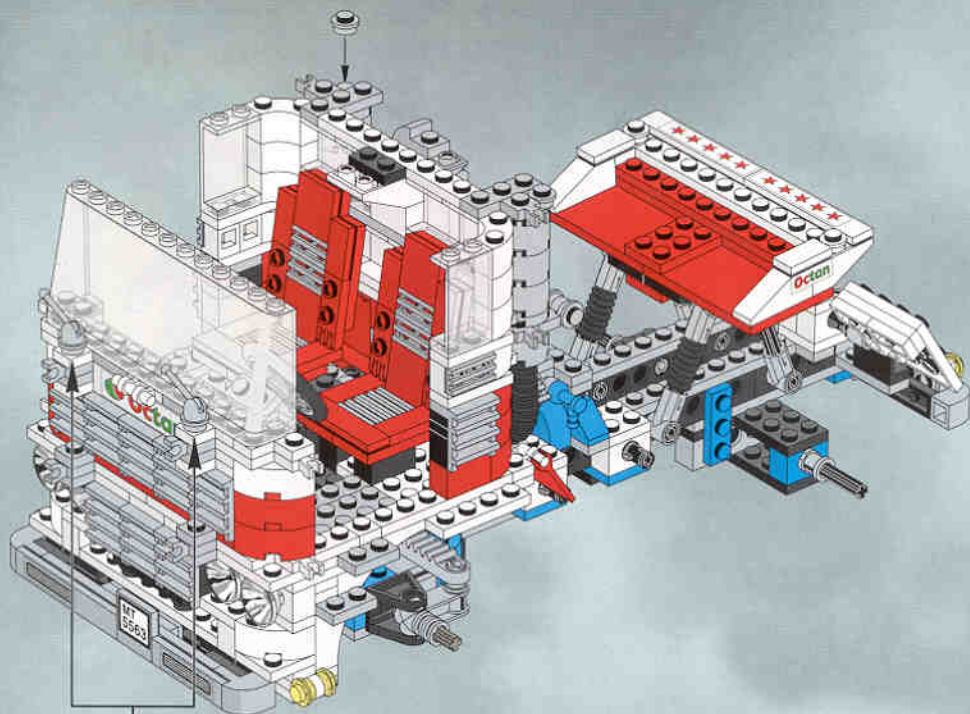

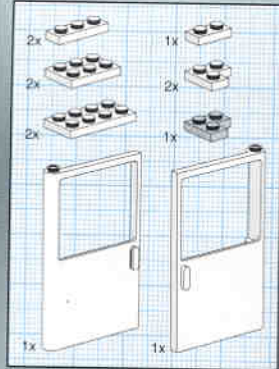

44

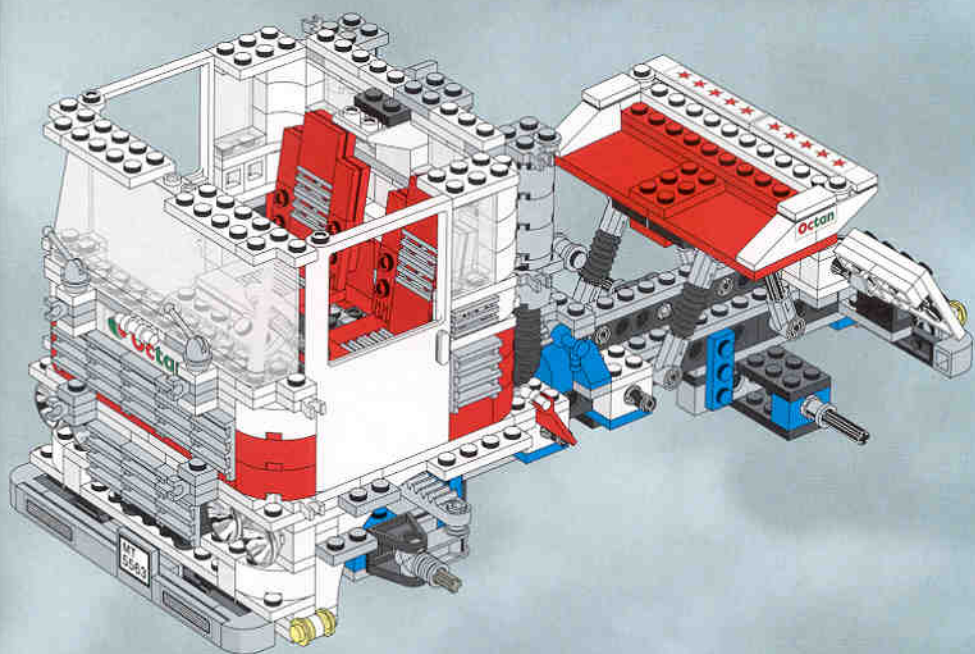

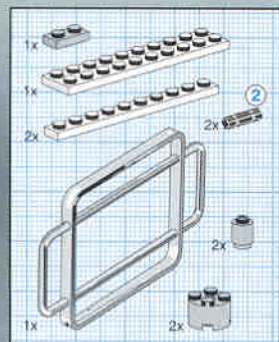

45

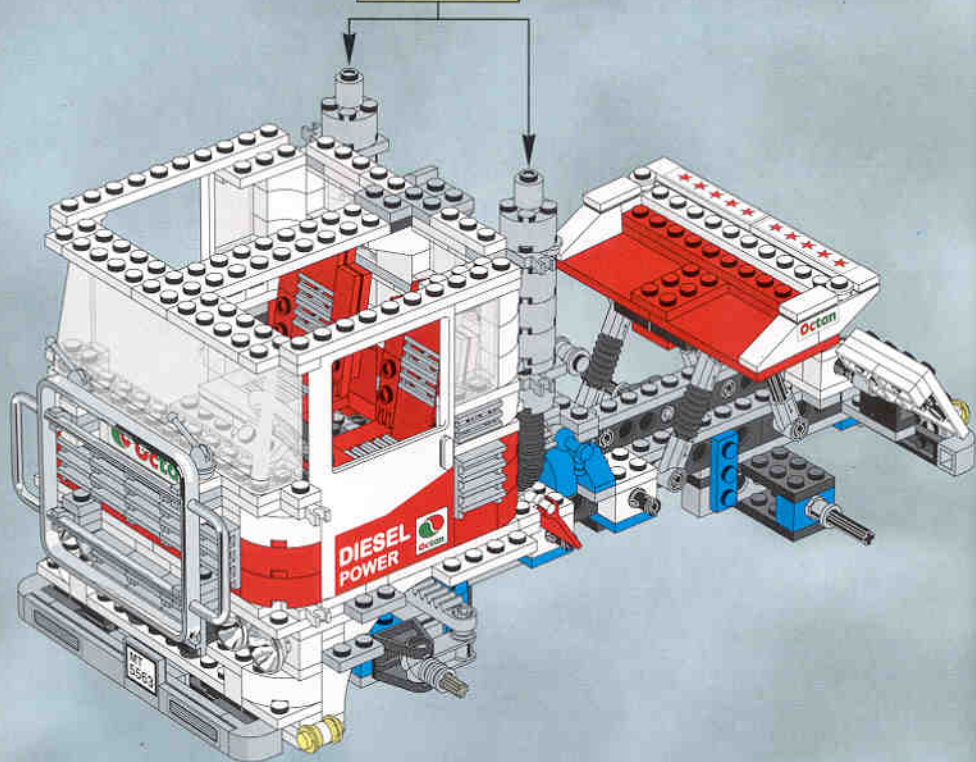

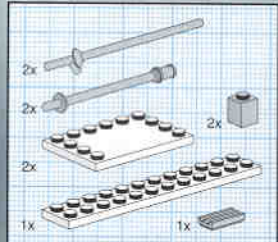

46

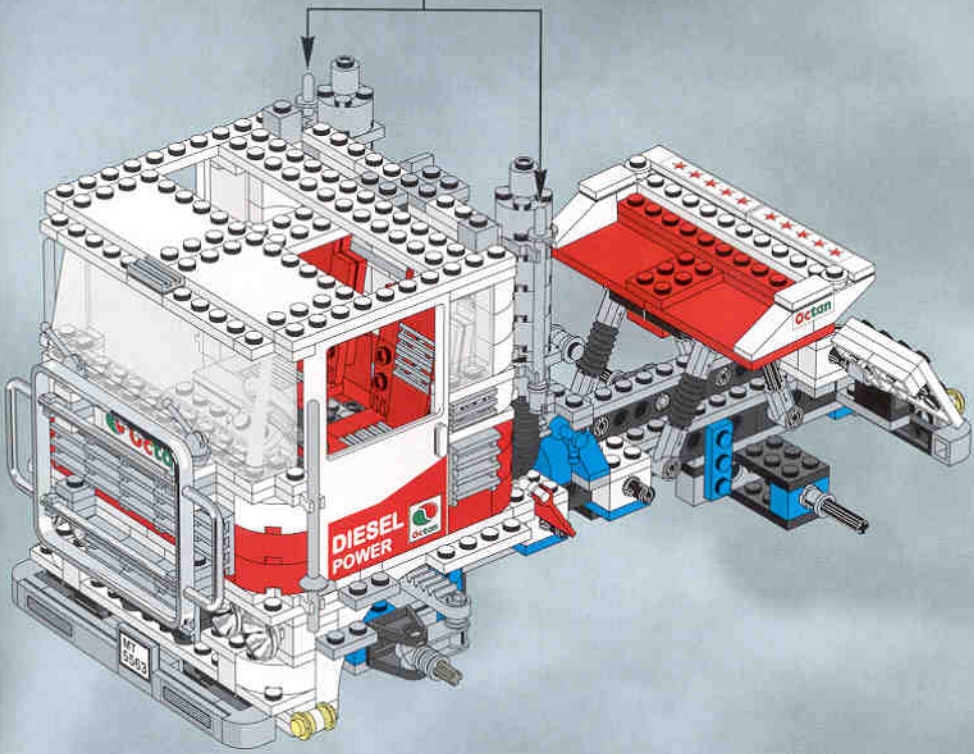
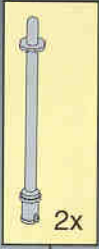

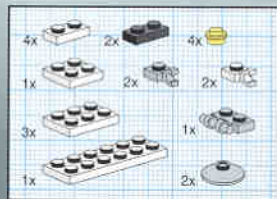

47

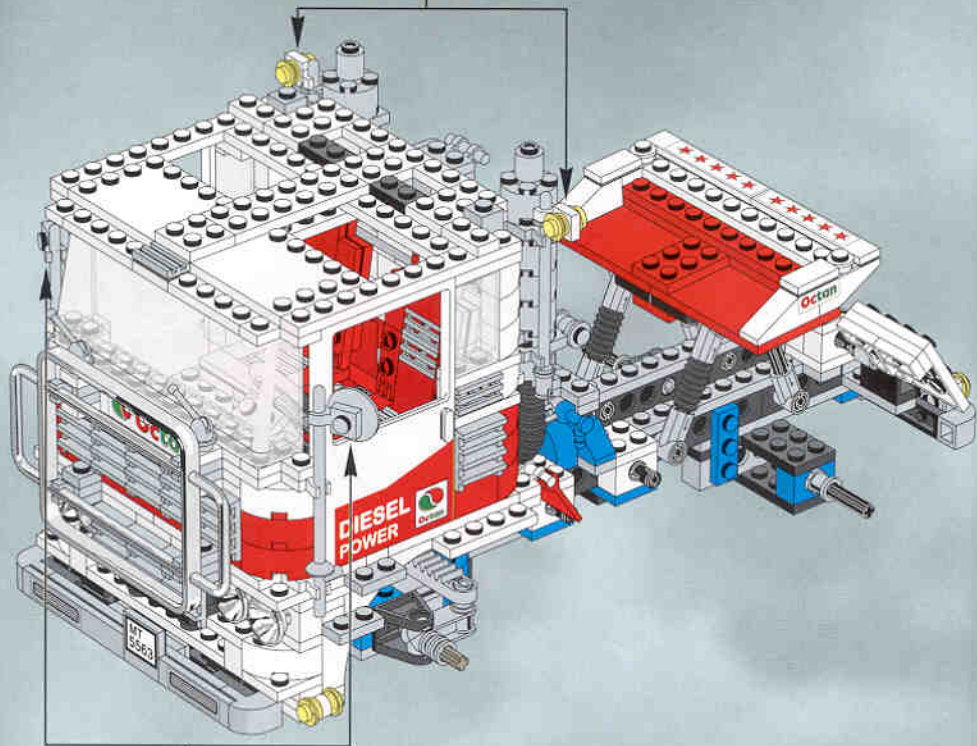
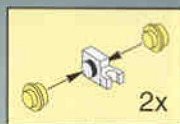

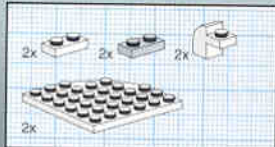

48

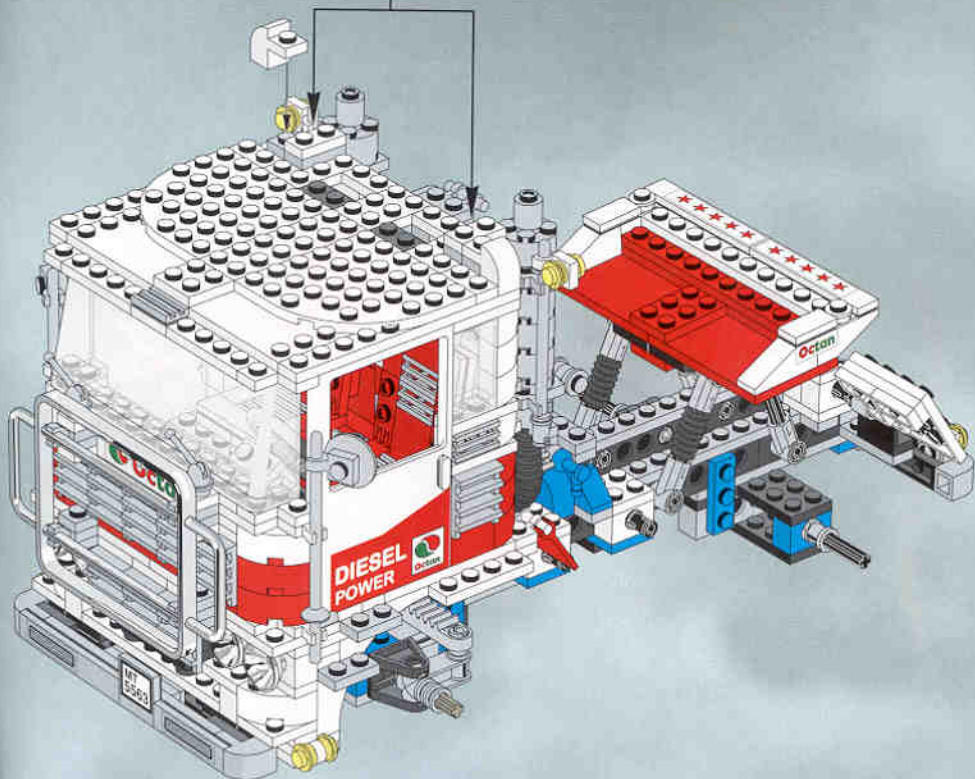
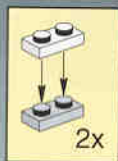

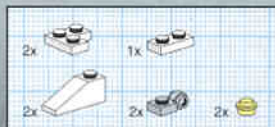

49

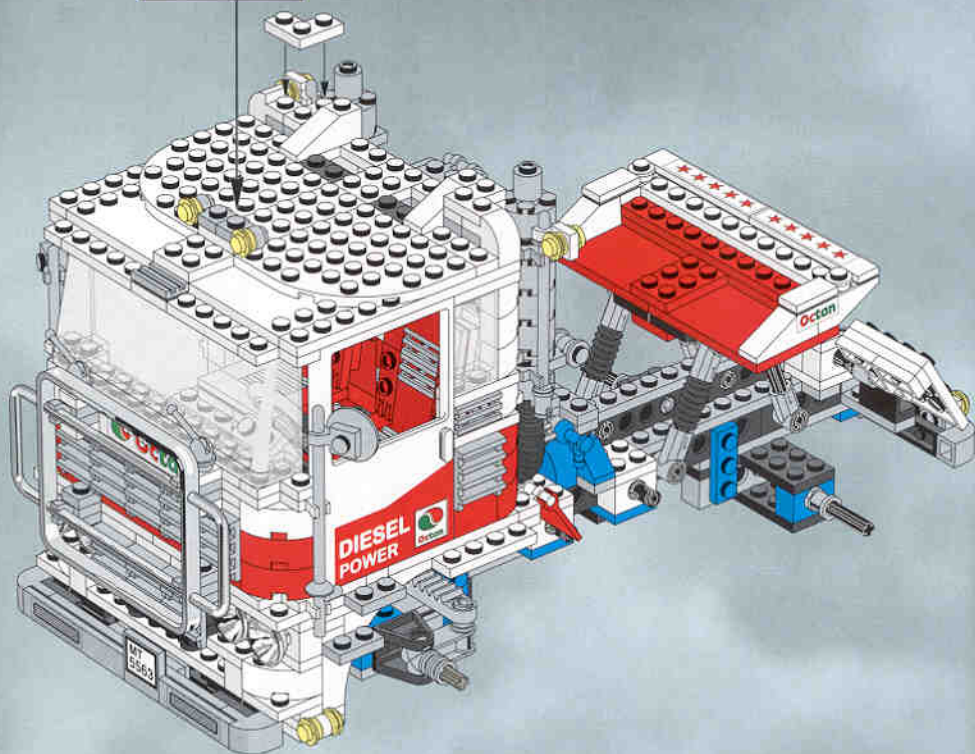
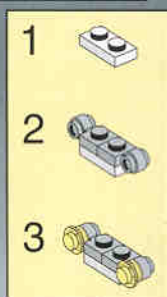

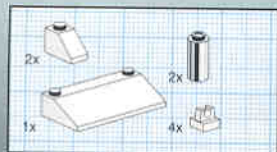

50

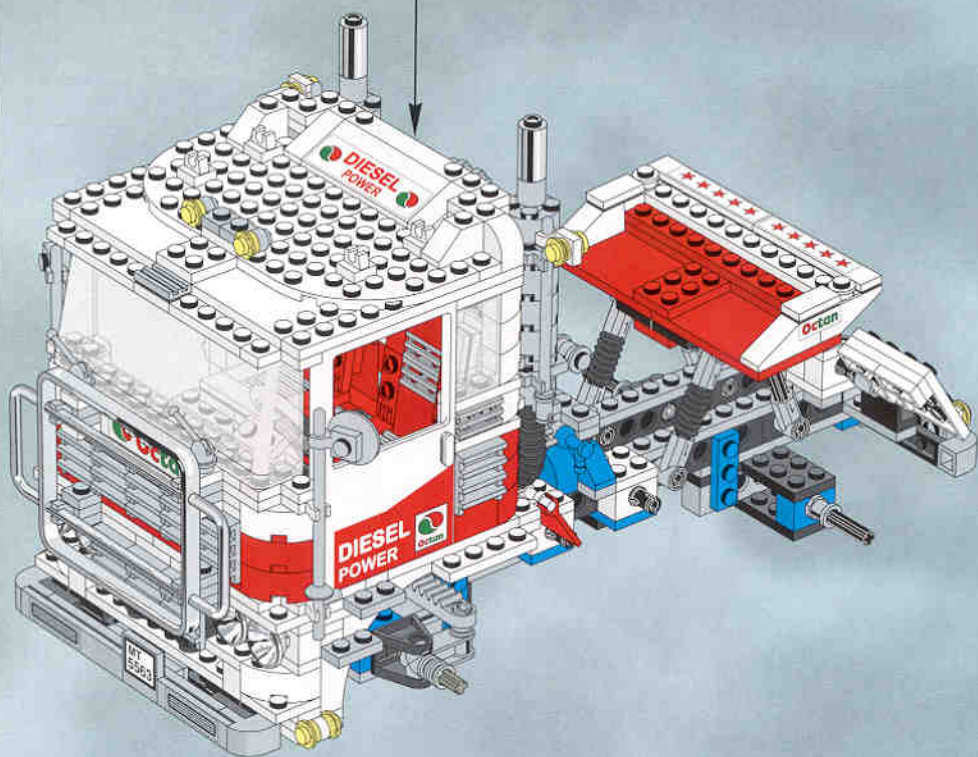
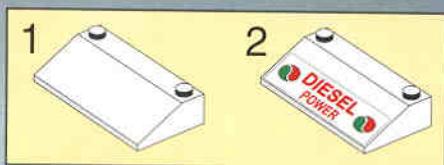

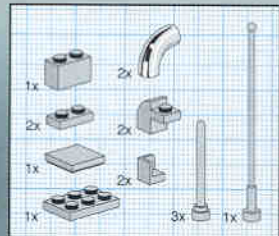

51

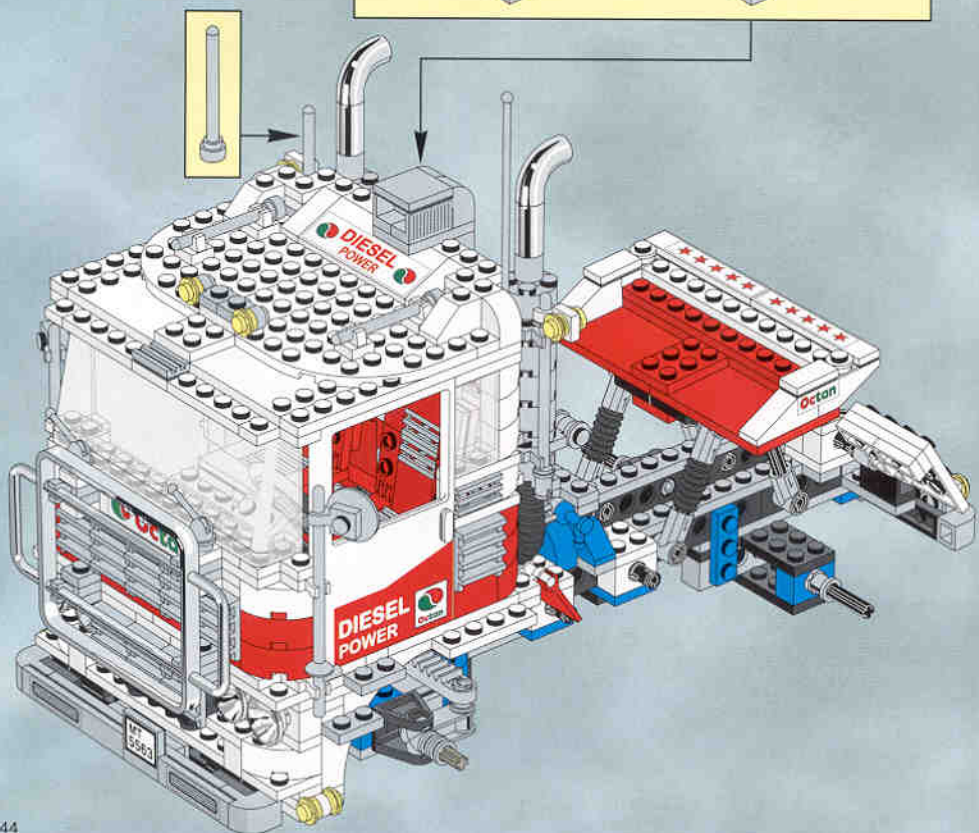
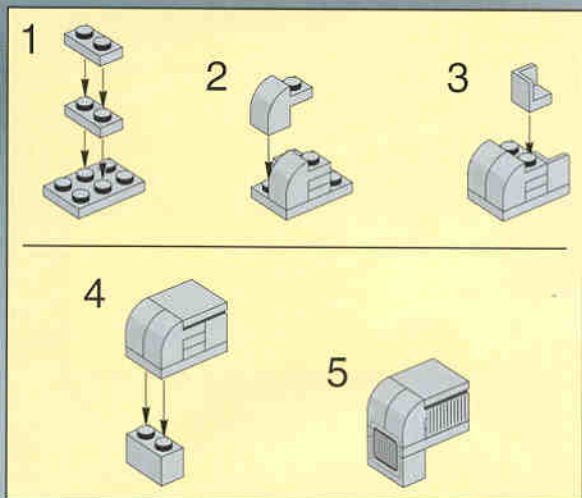



52

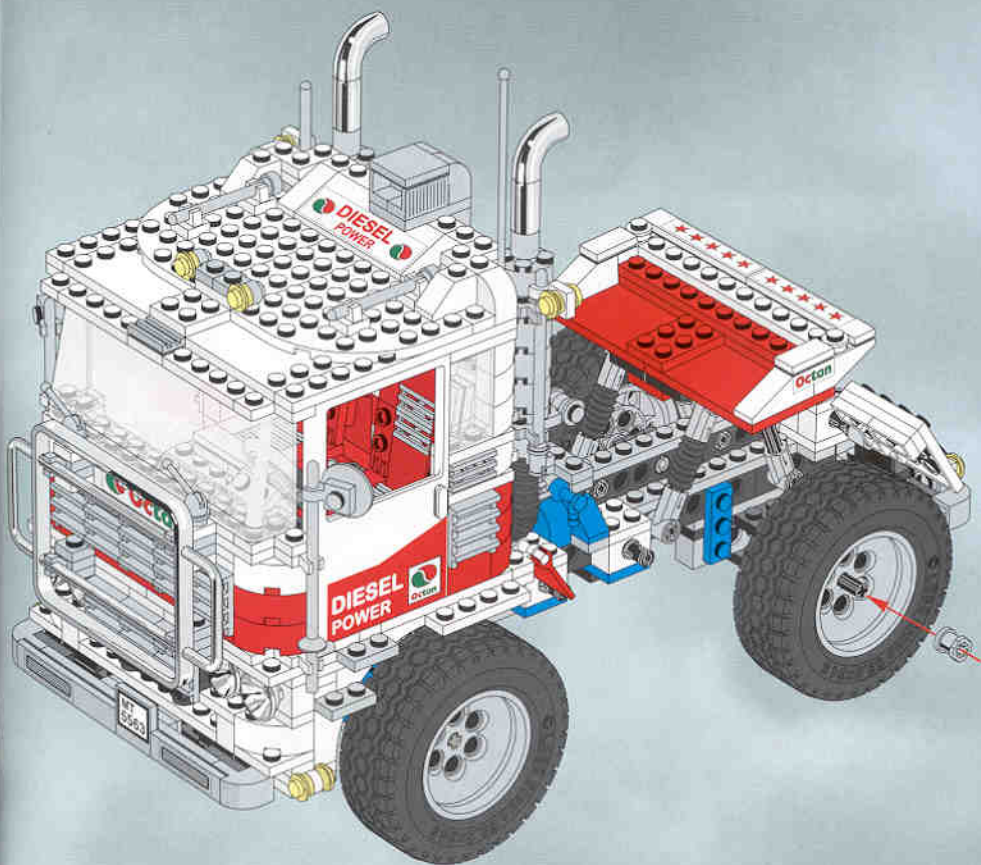

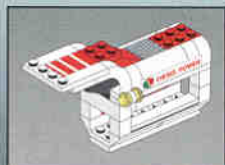

1

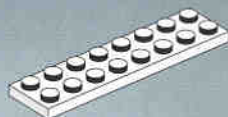

2

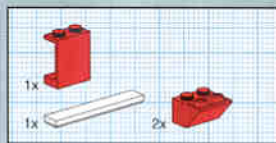
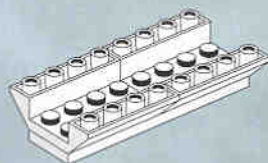

3

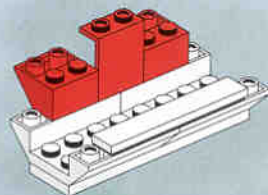

4

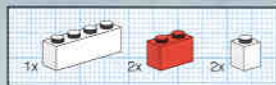
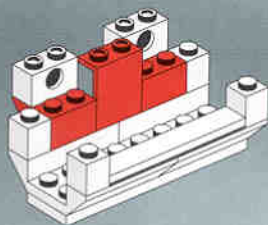

5

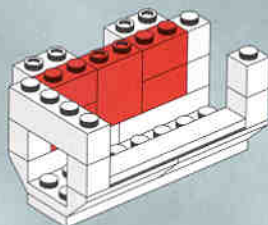

6

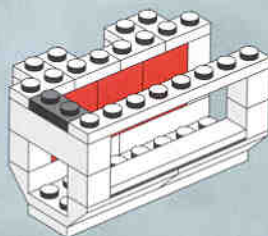

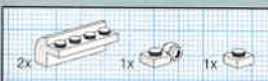

7

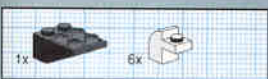
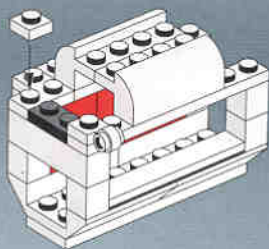

8

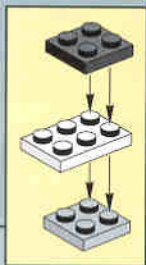
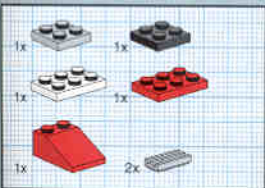
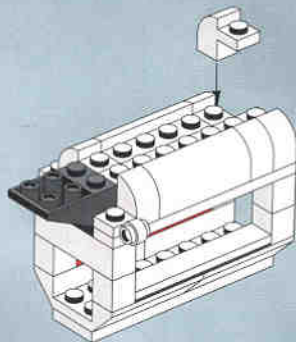

9

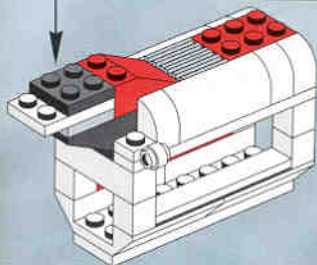

10

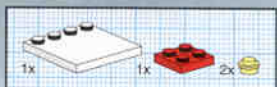
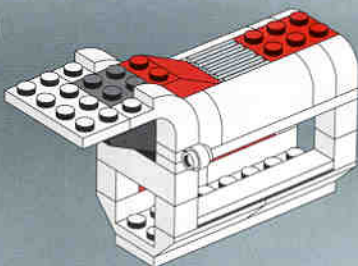

11

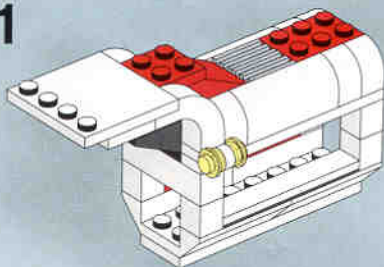

12

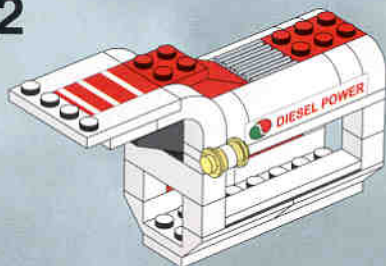

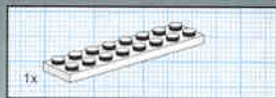
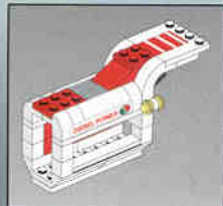

1

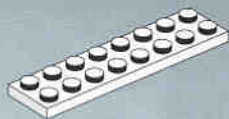

2

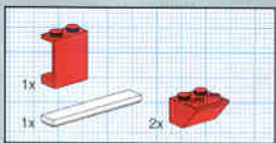
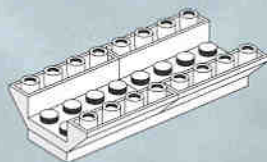

3

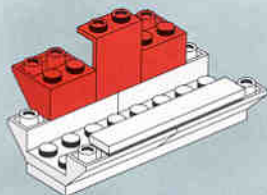

4

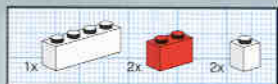
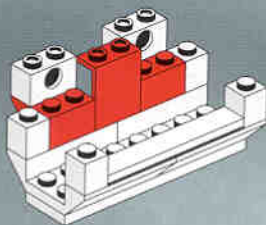

5

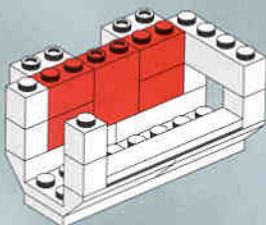

6

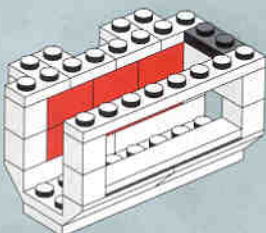

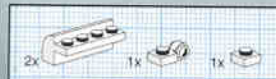

7

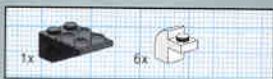
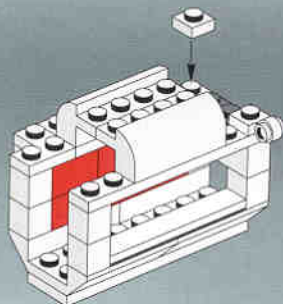

8

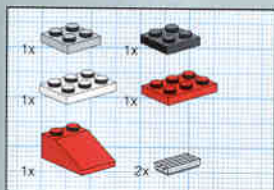
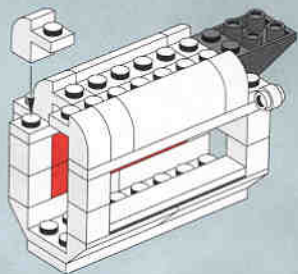

9

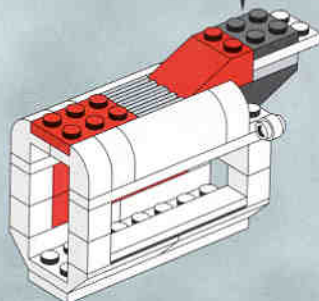

10

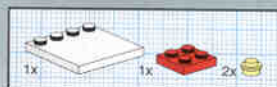
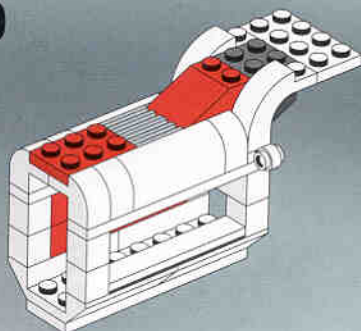

11

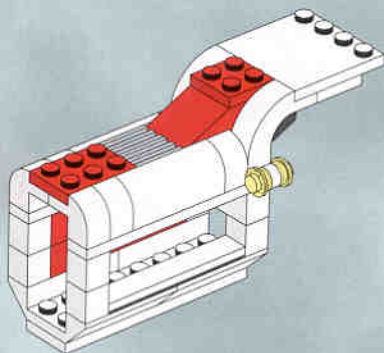

12

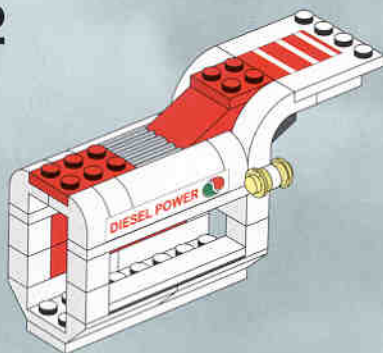

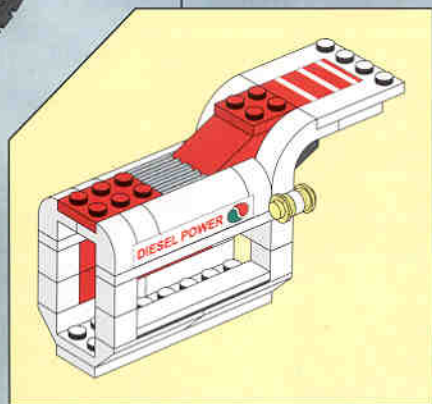
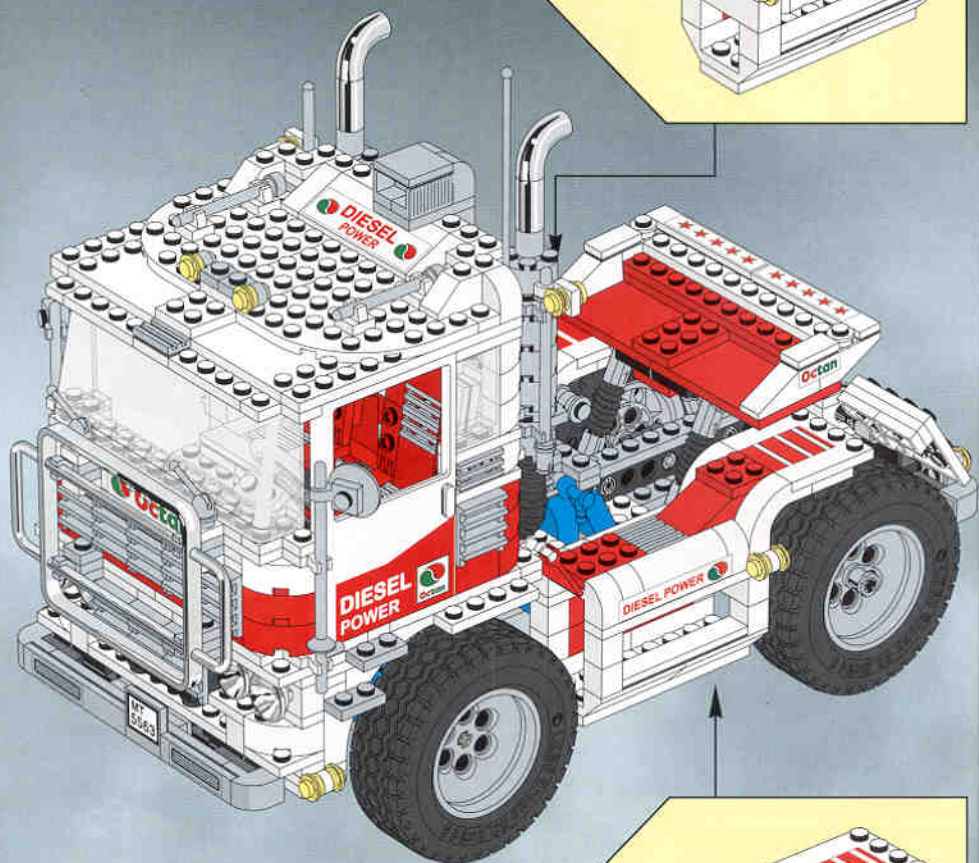



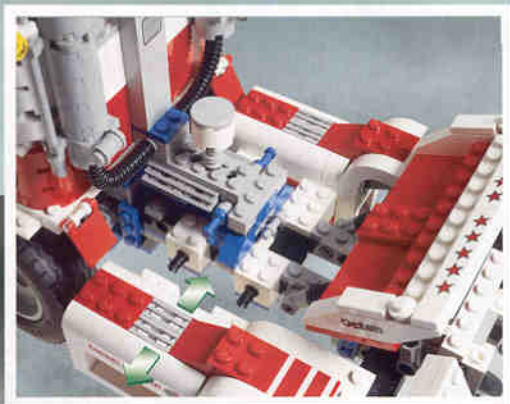



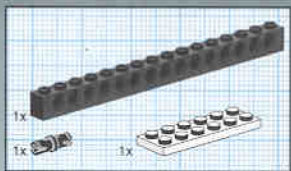

1

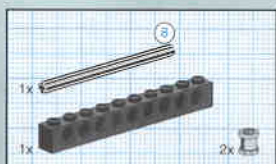
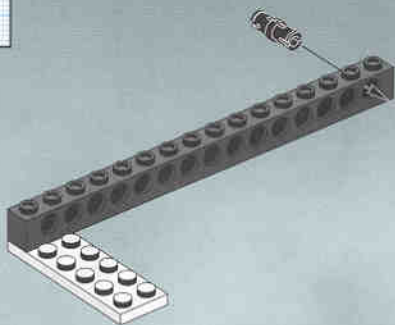

2

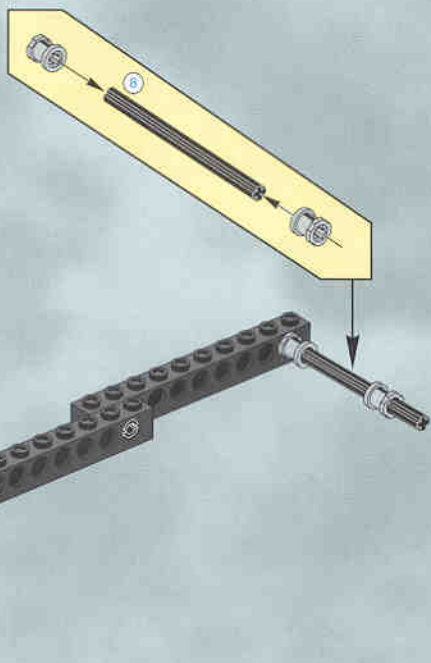



3

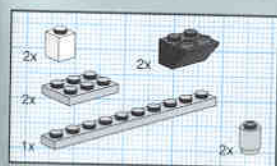
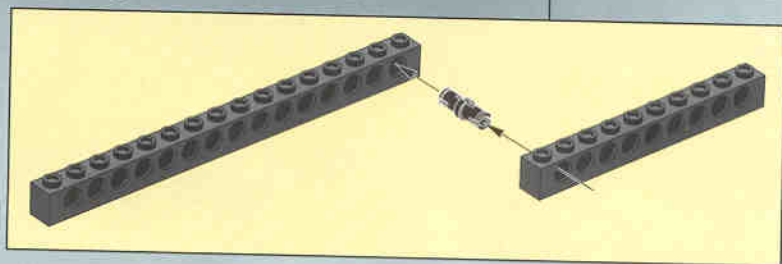
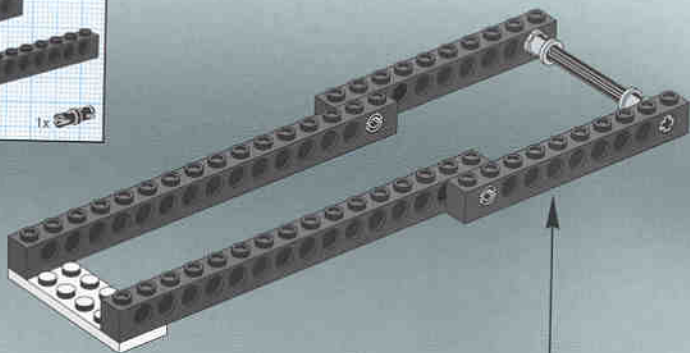

4

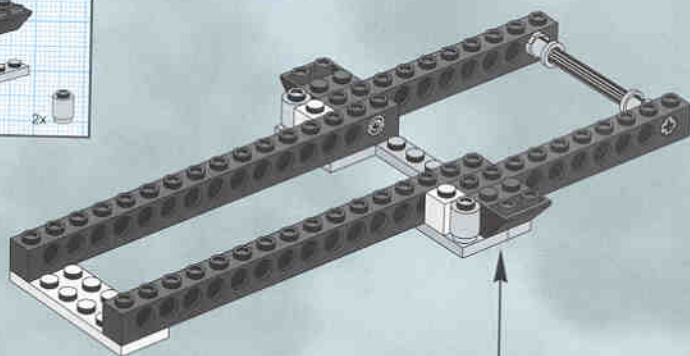

1

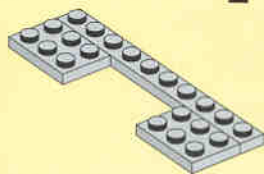

2

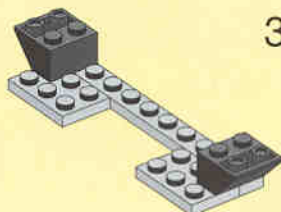

3

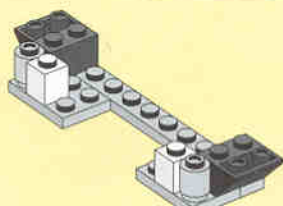



5

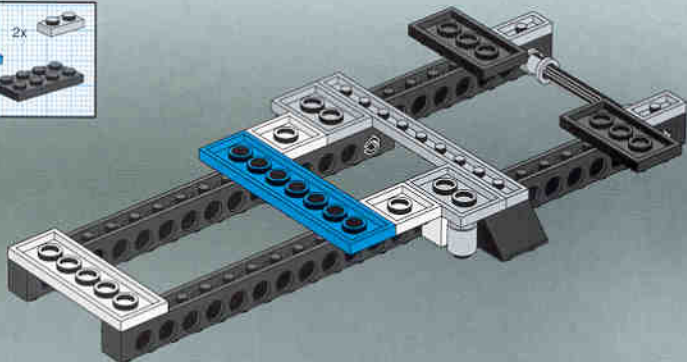

6

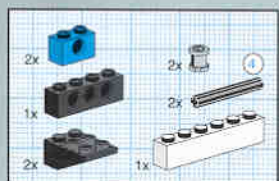
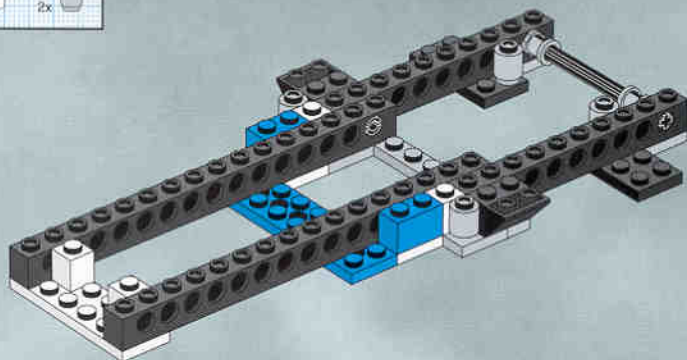

7

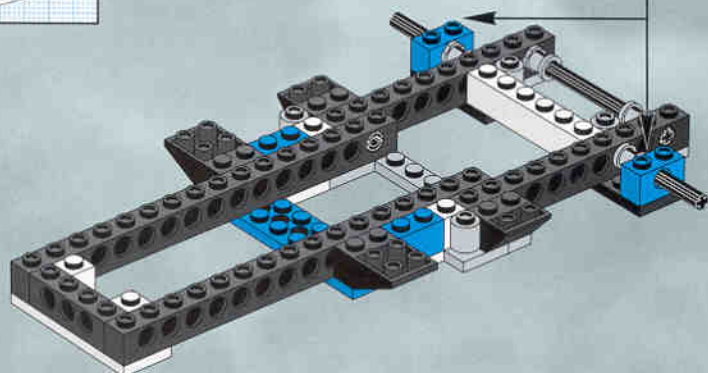
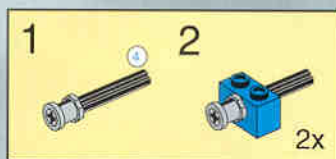



8

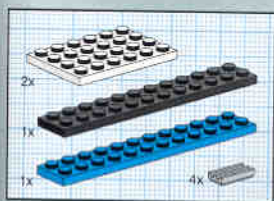
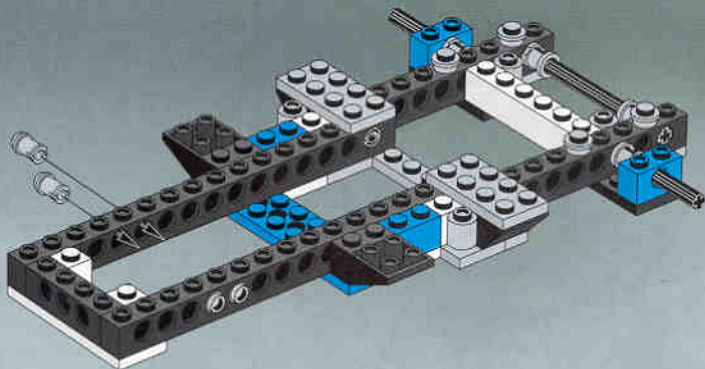

9

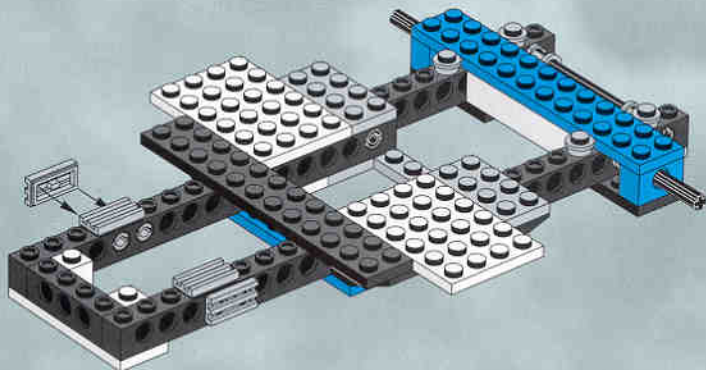

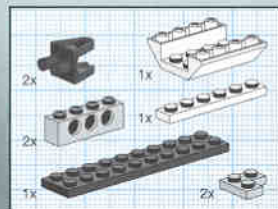

10

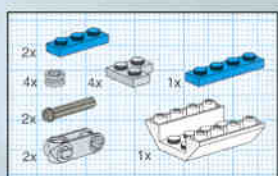
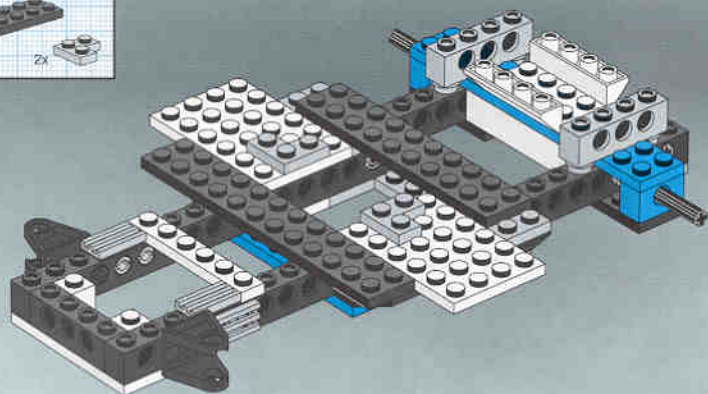

11

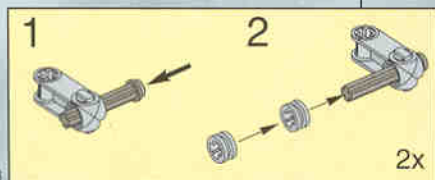
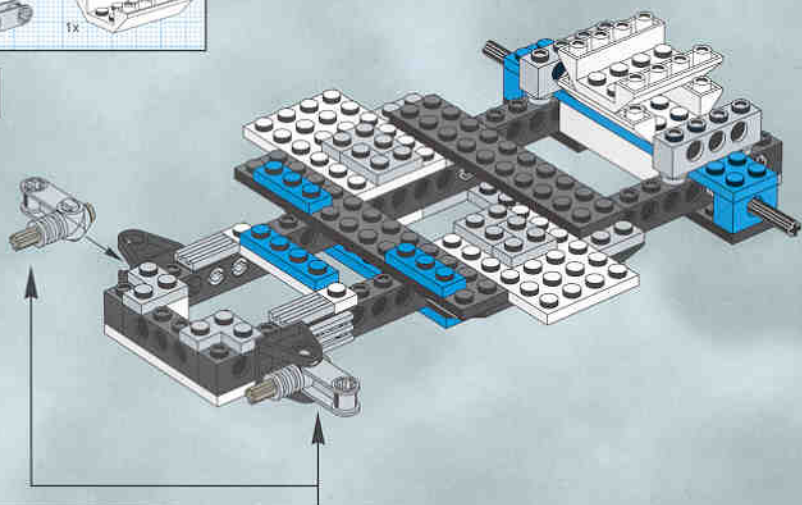

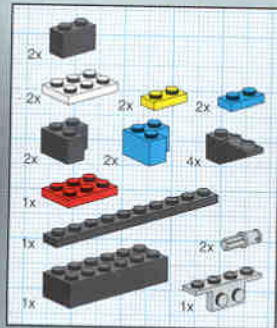

12

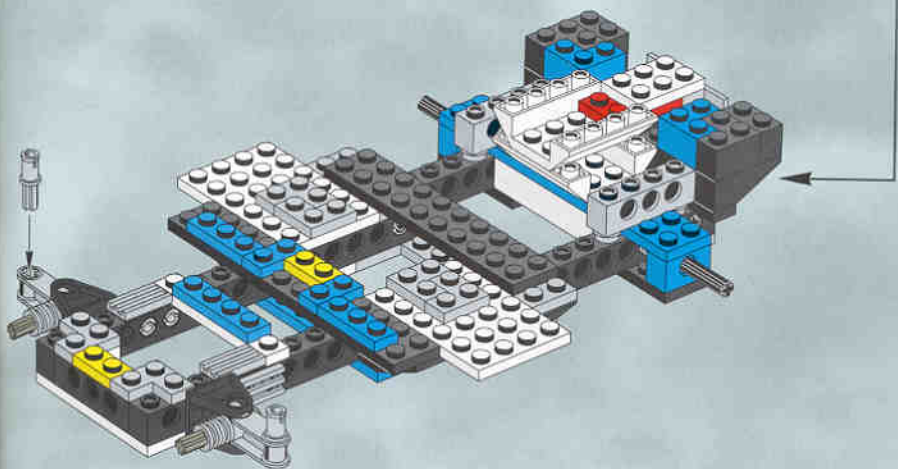
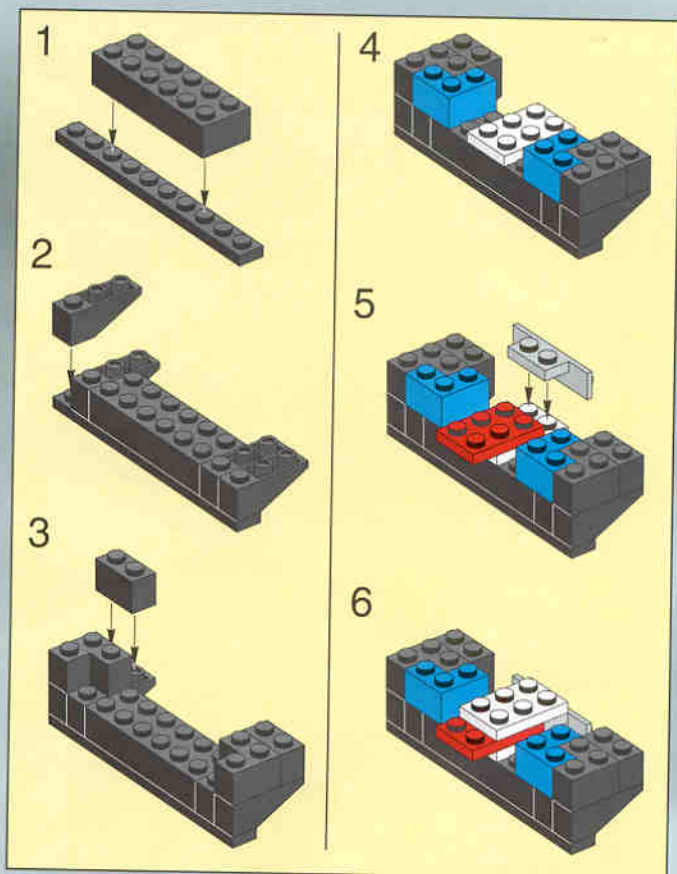

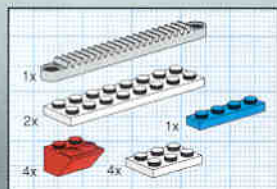

13

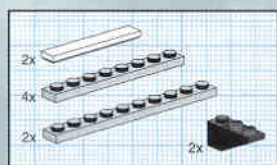
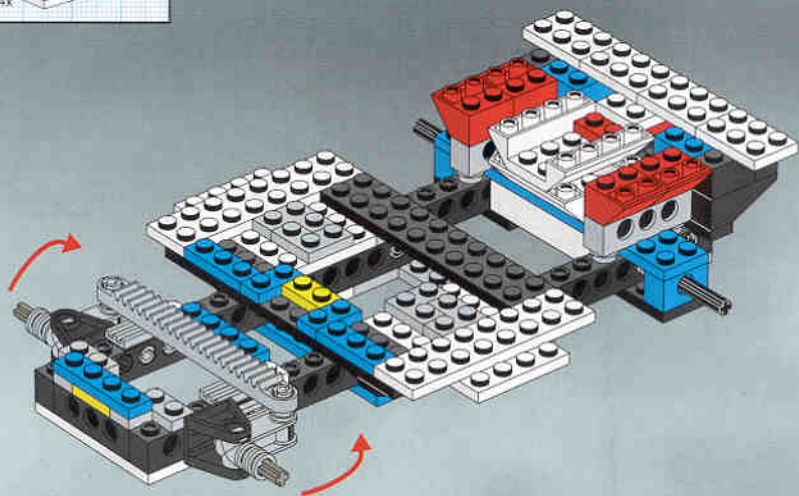

14

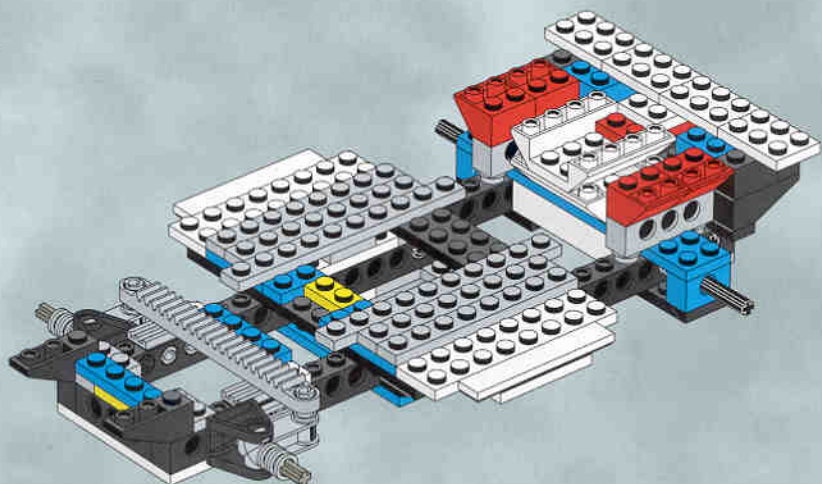



17

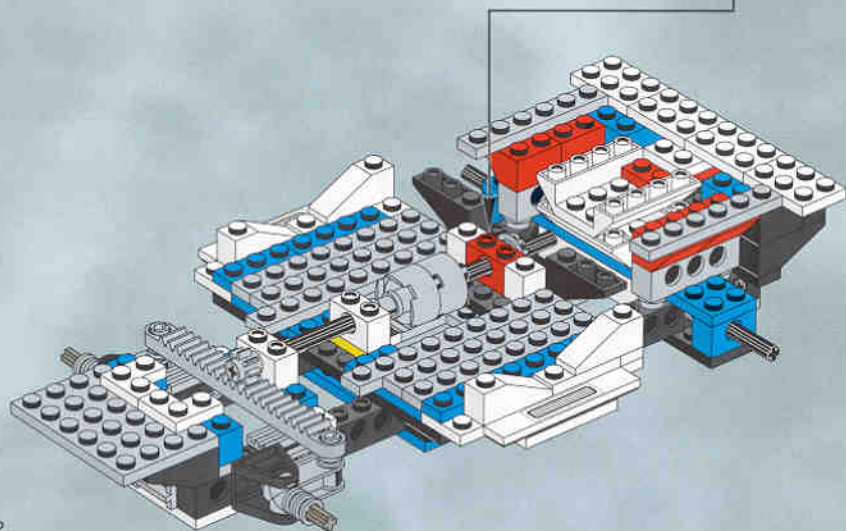
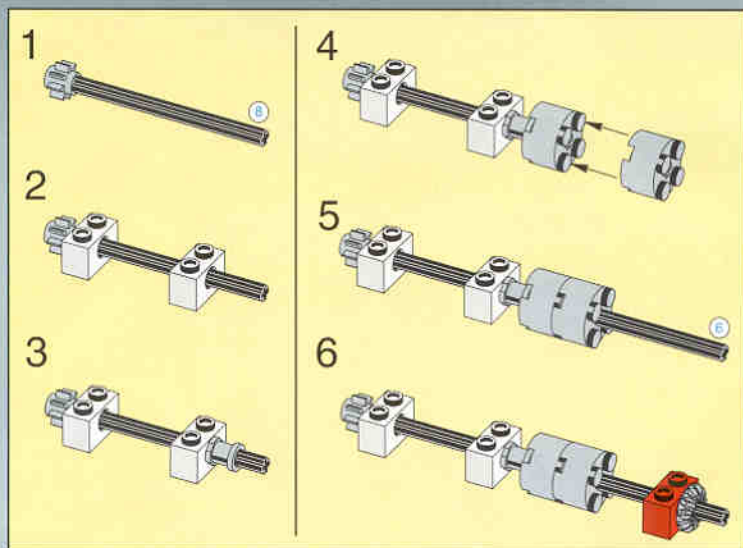

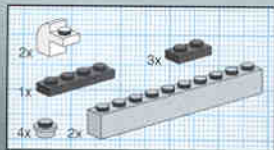

18

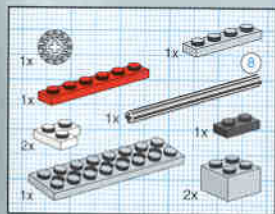
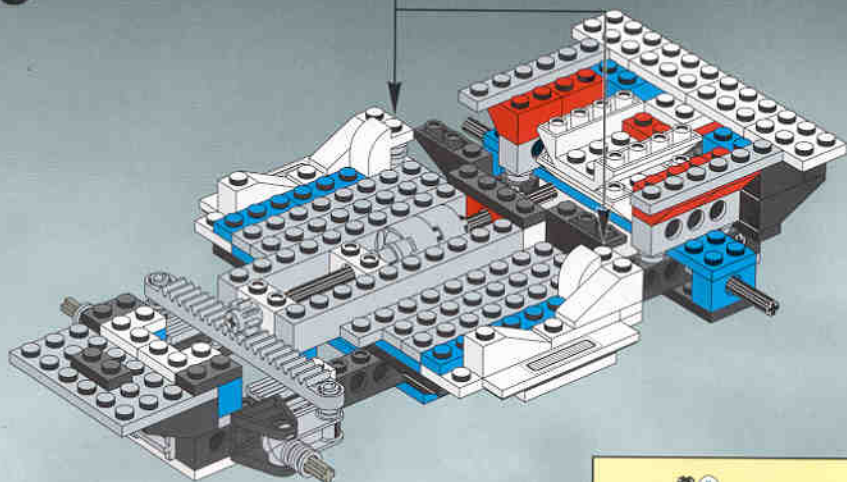

19

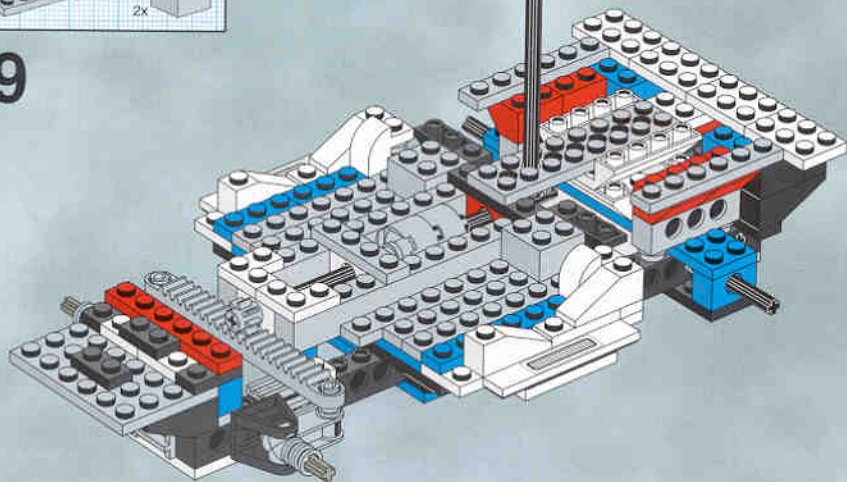
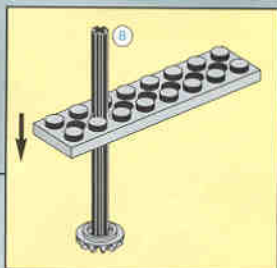

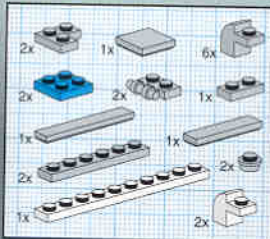

21

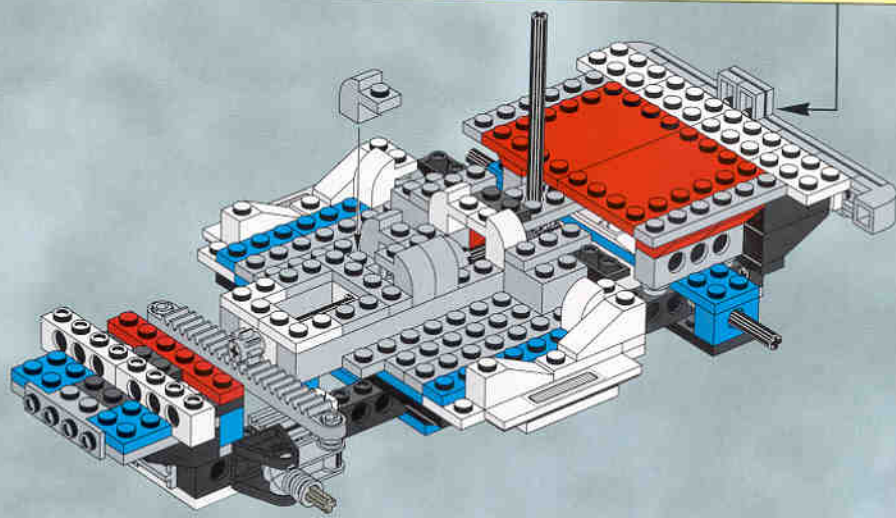
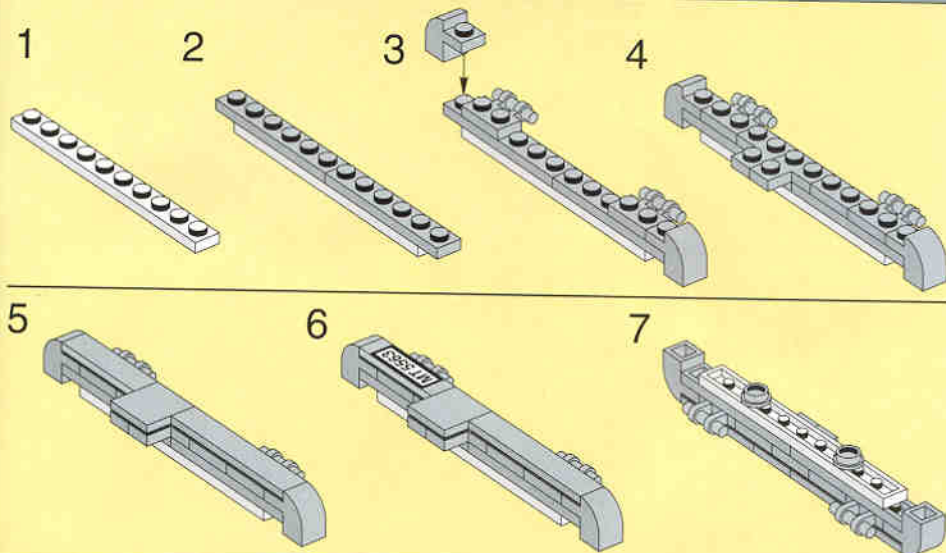

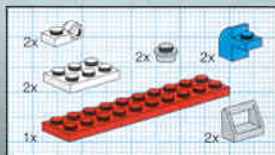

22

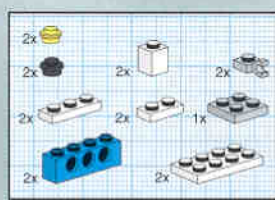
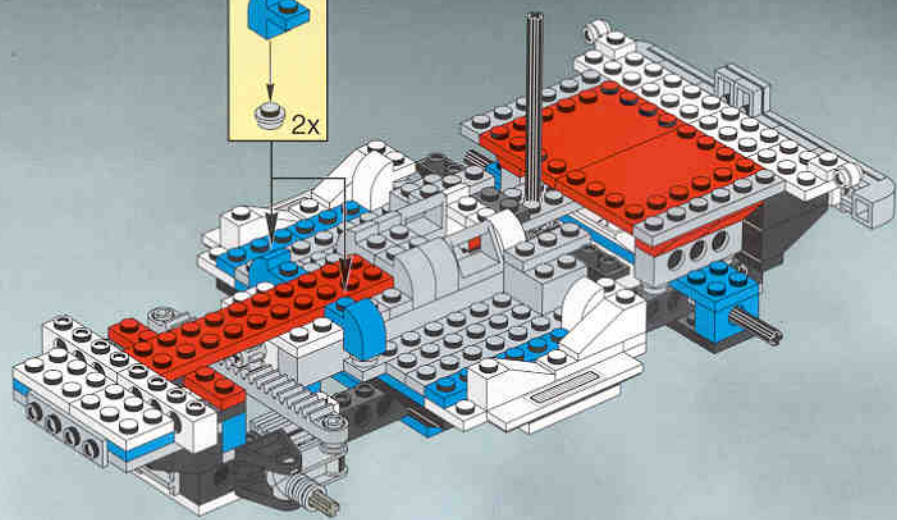
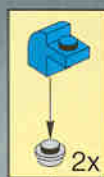

23

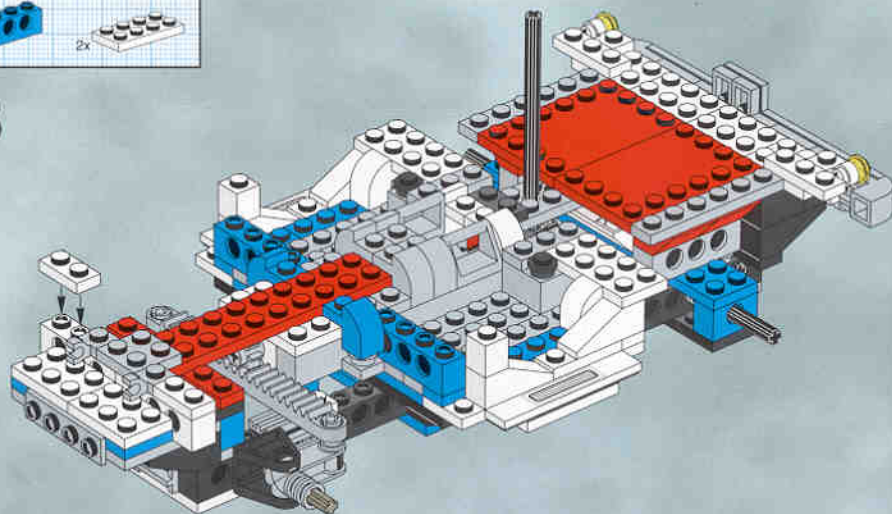

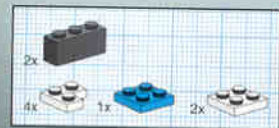

24

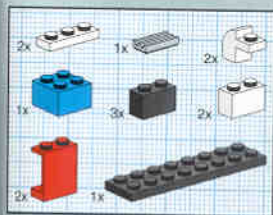
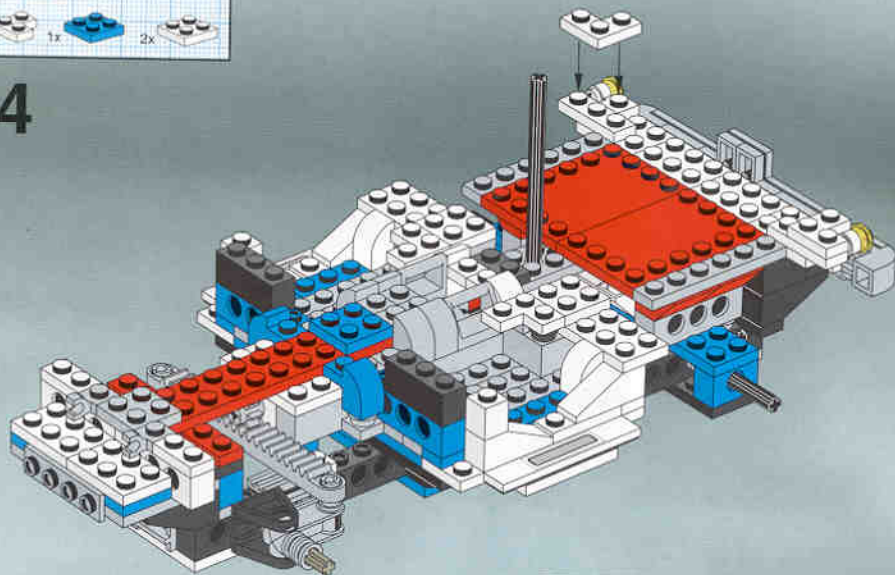

25

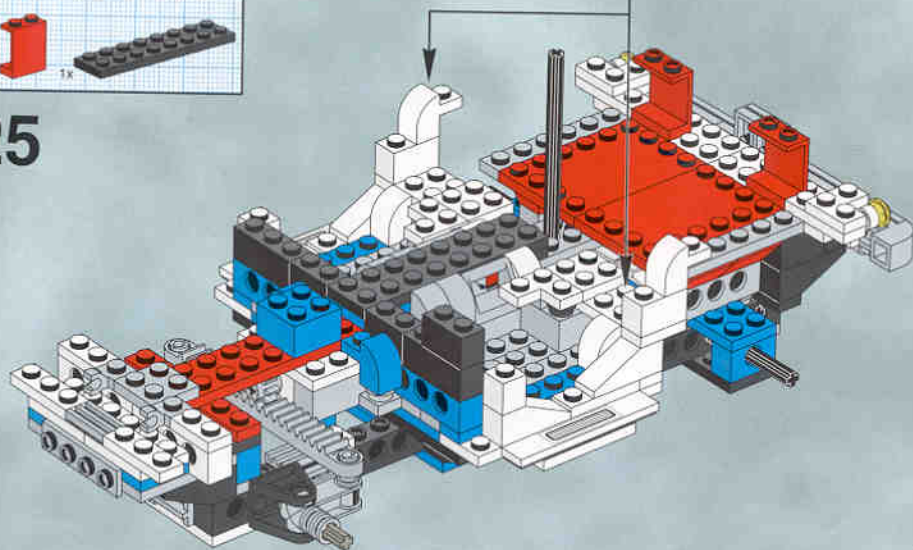
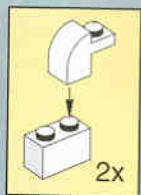

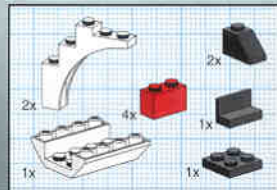

26

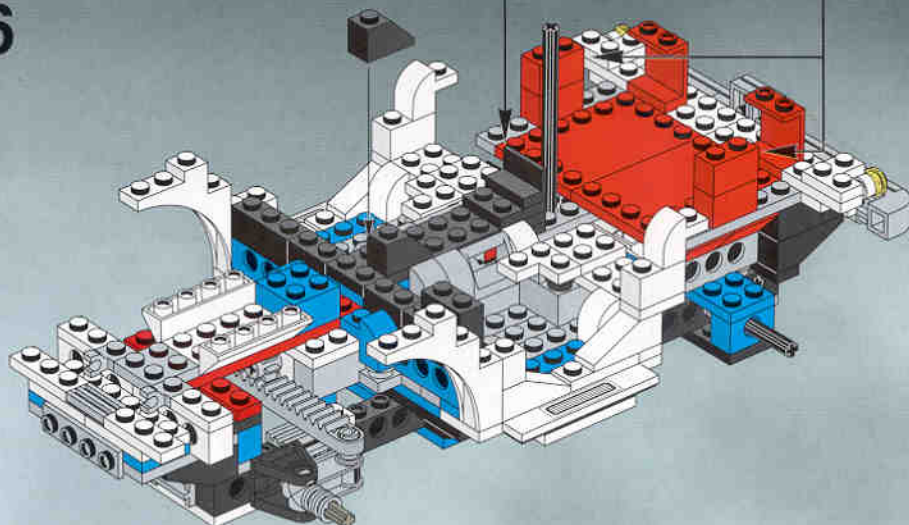
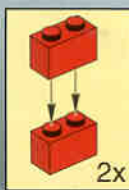

27

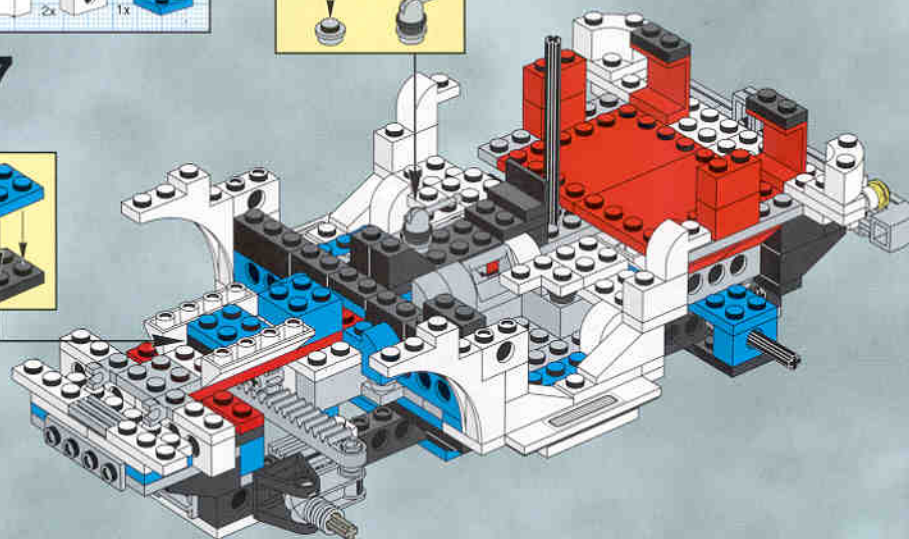

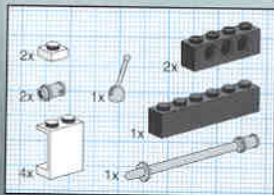

28

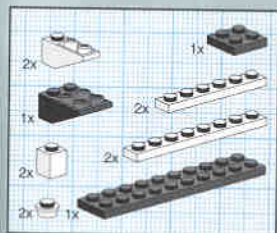
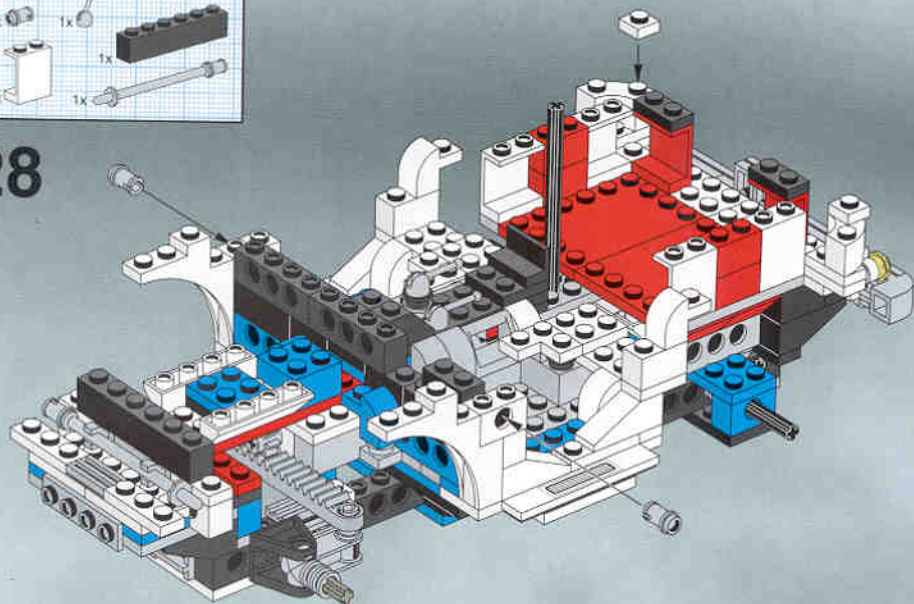

29

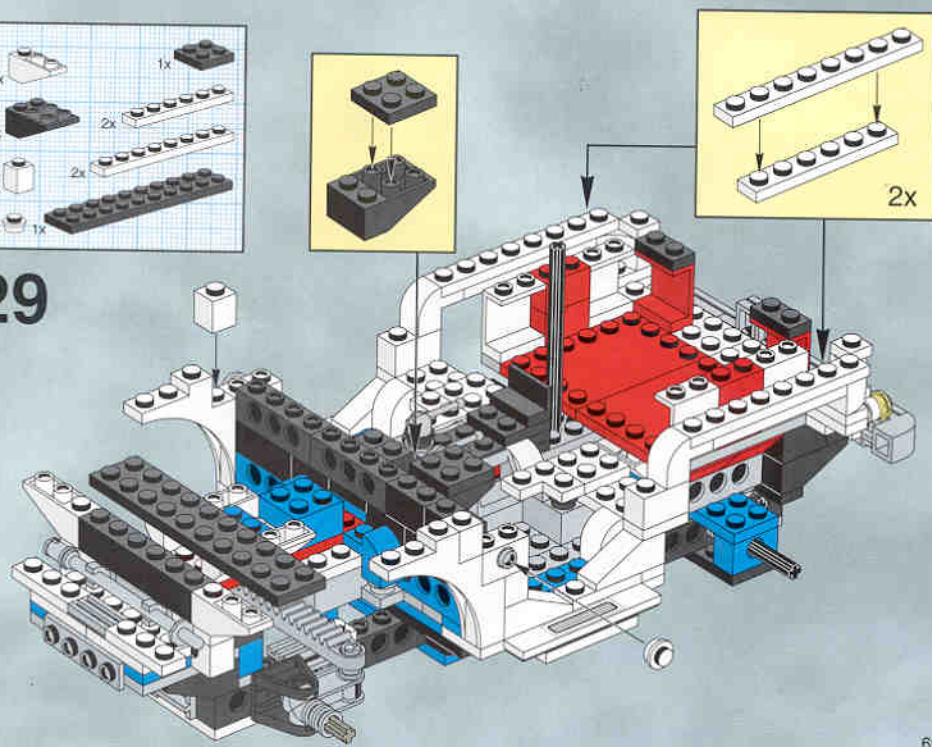

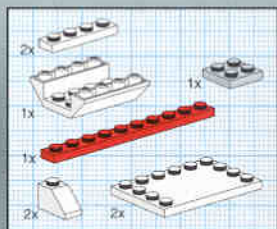

30

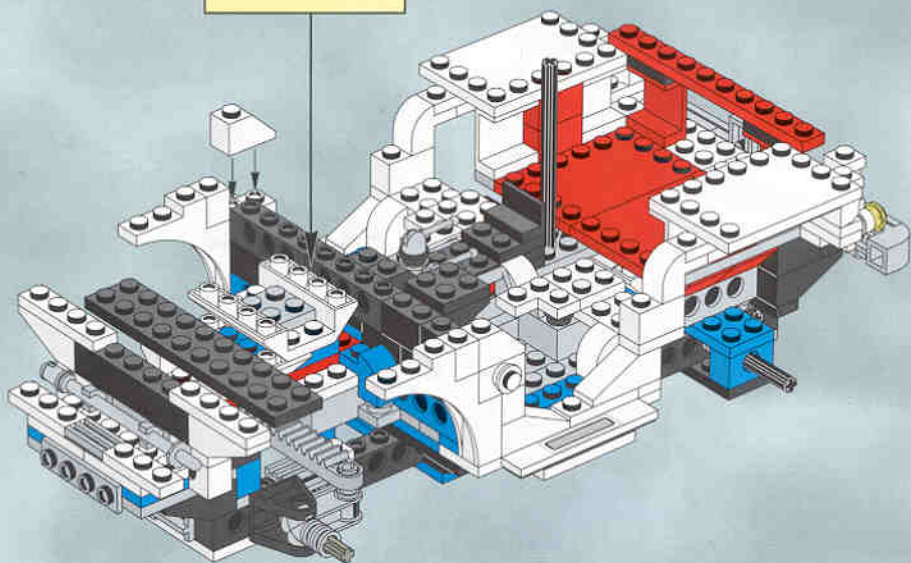
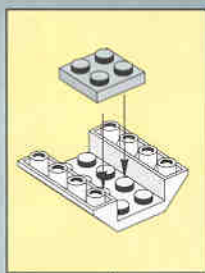

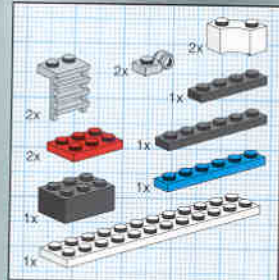

31

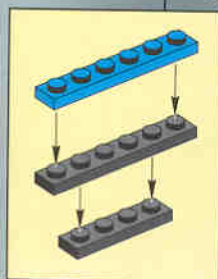
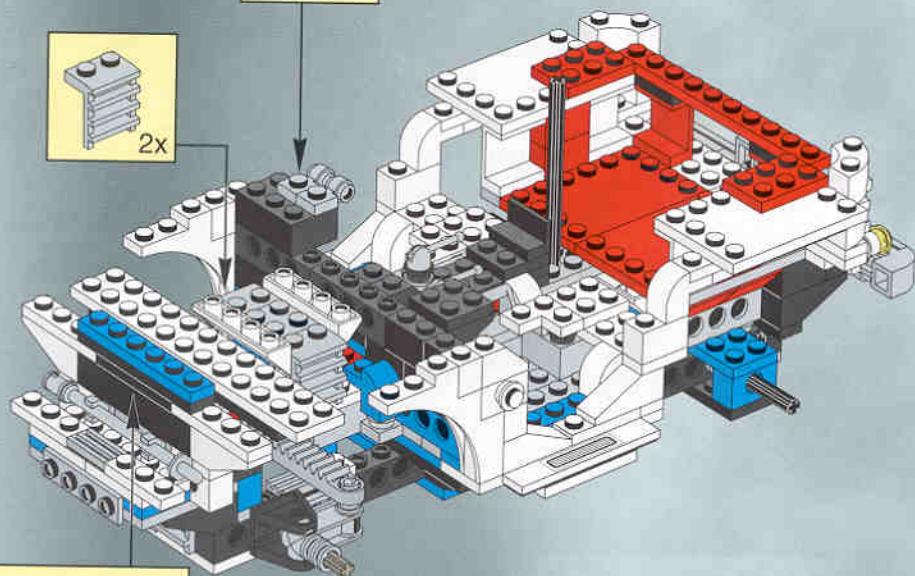

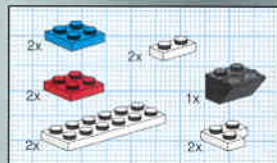

32

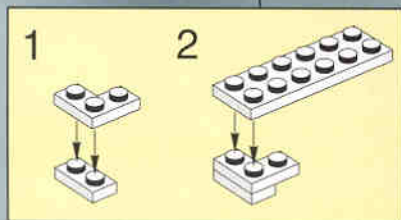
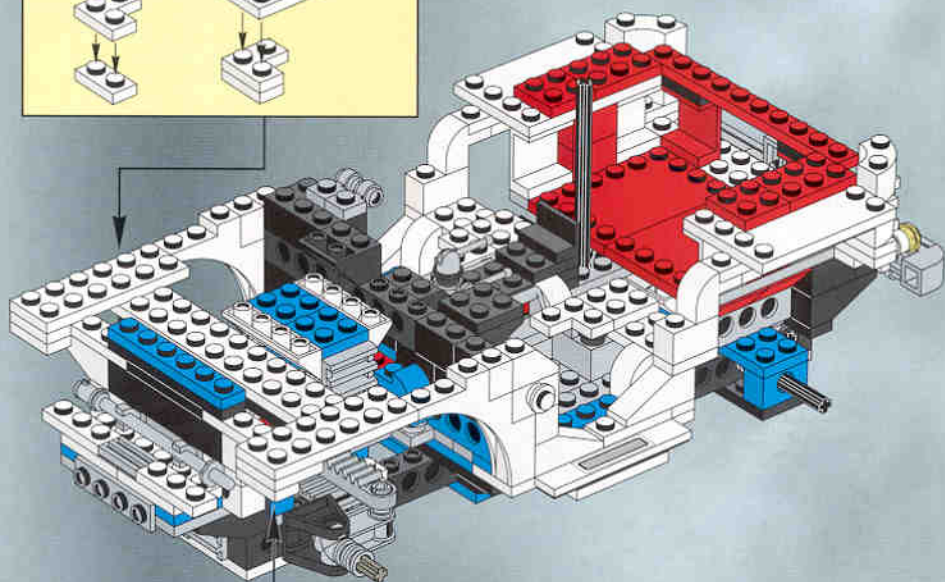
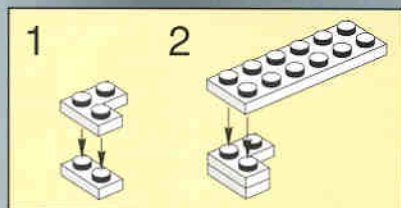

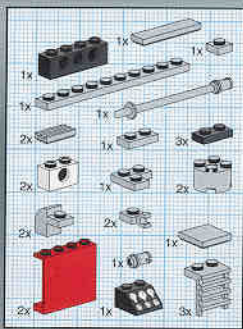

33

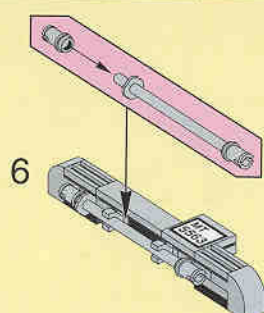
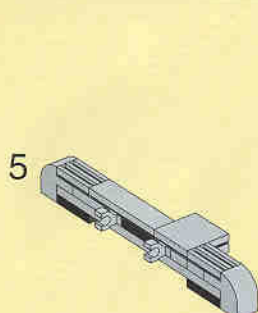
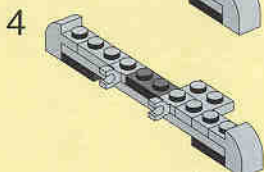
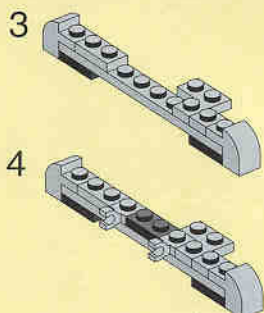
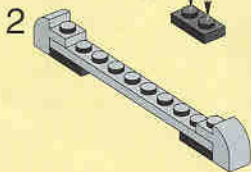
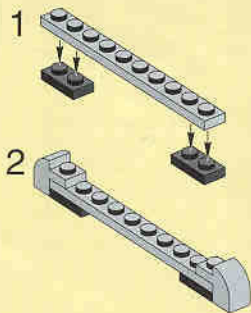
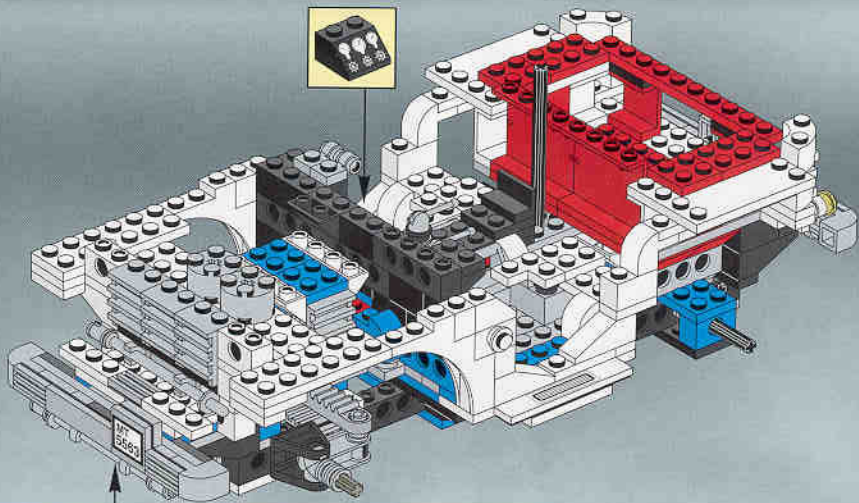



34

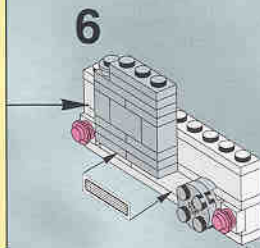
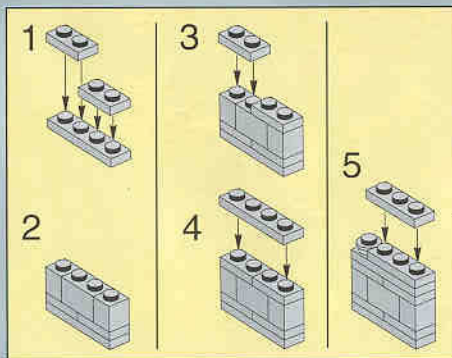
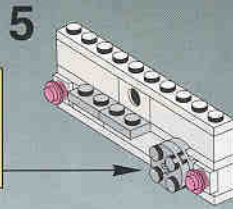
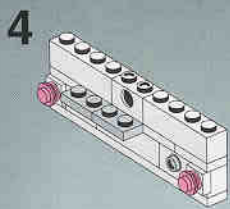
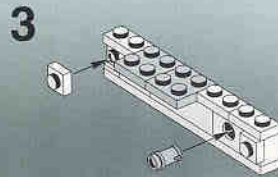
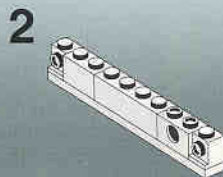
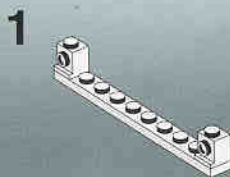

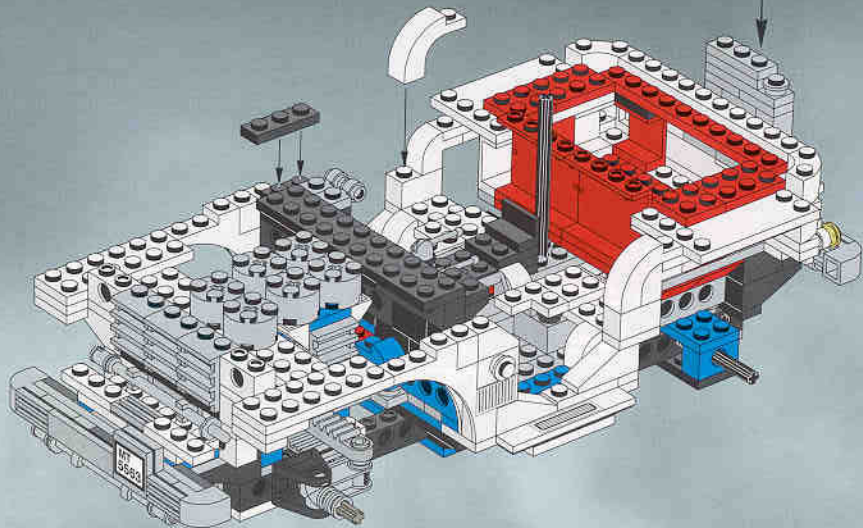

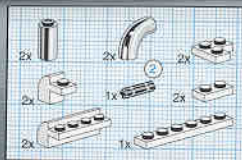

36

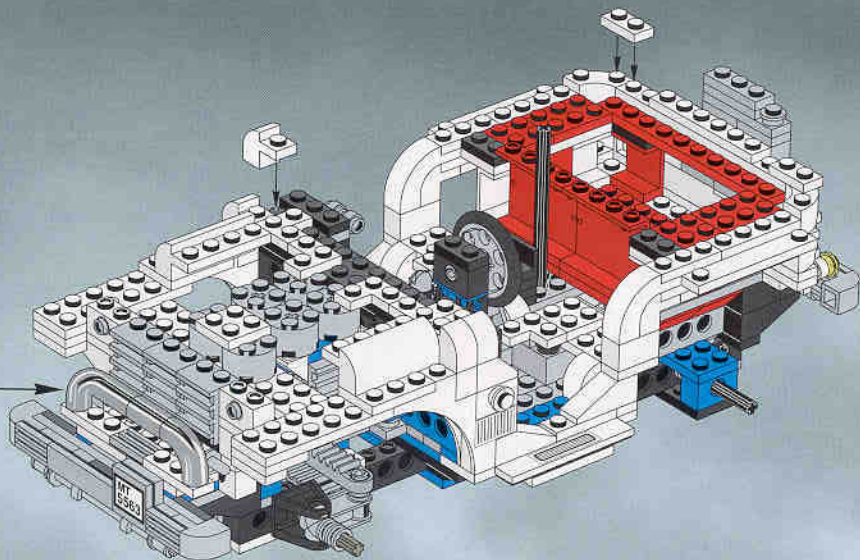
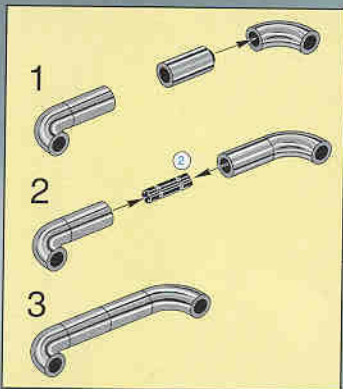

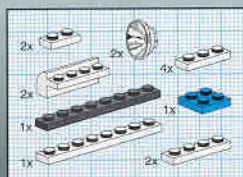

37

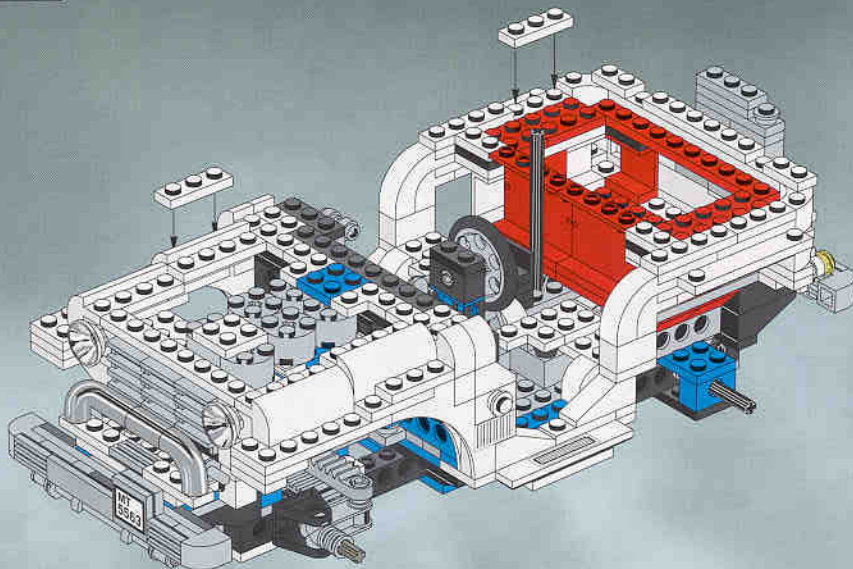

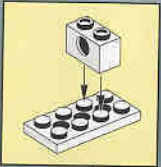
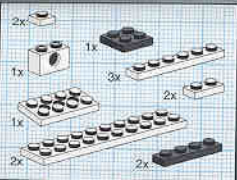

38

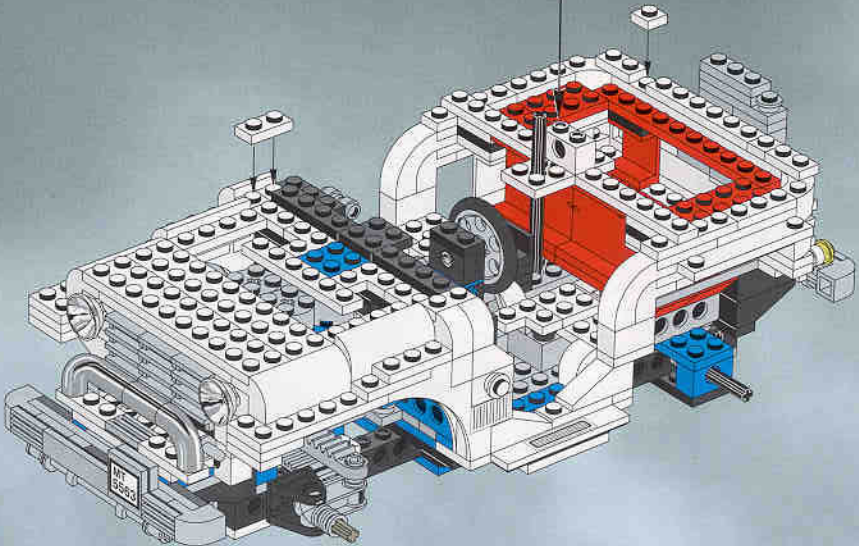

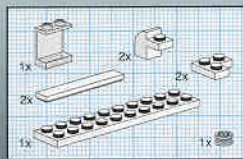

39

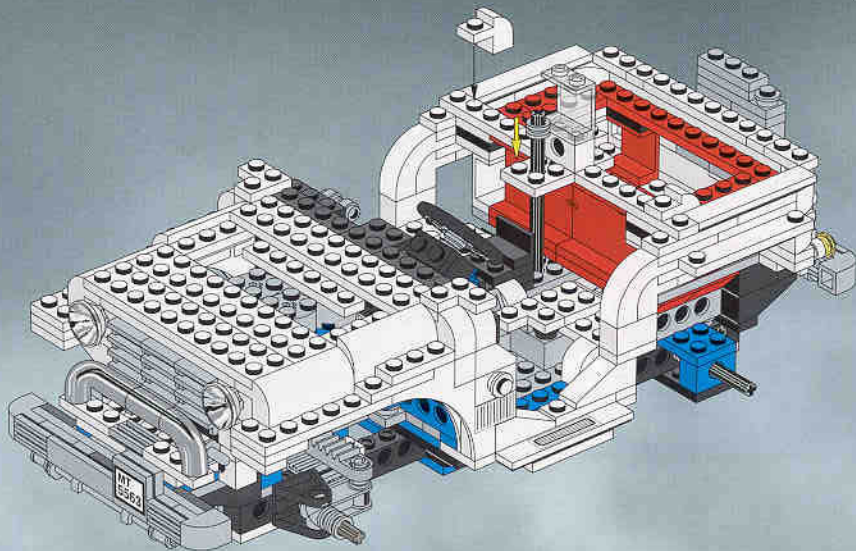



40

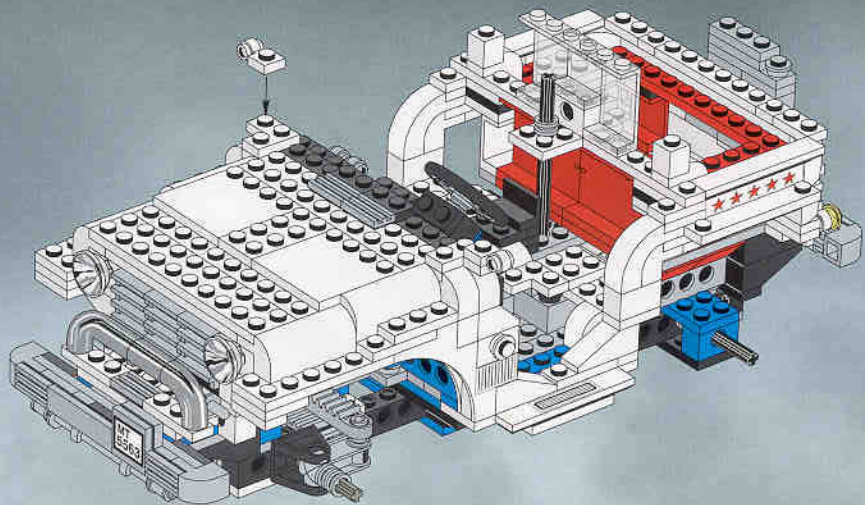

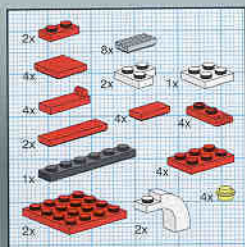

41

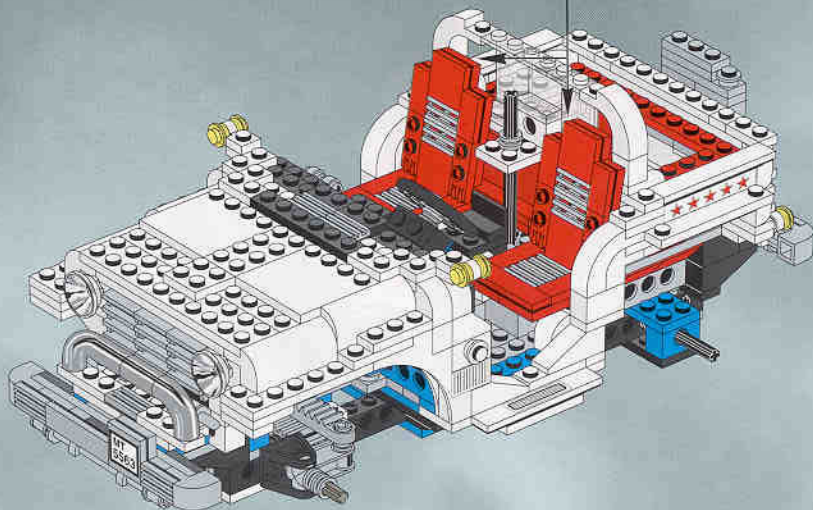
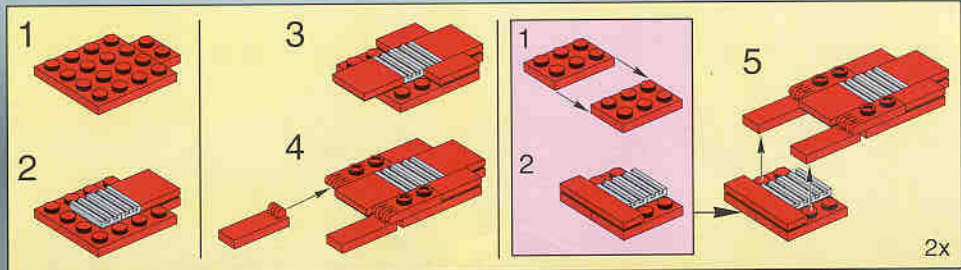

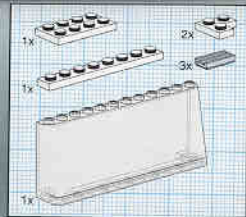

42

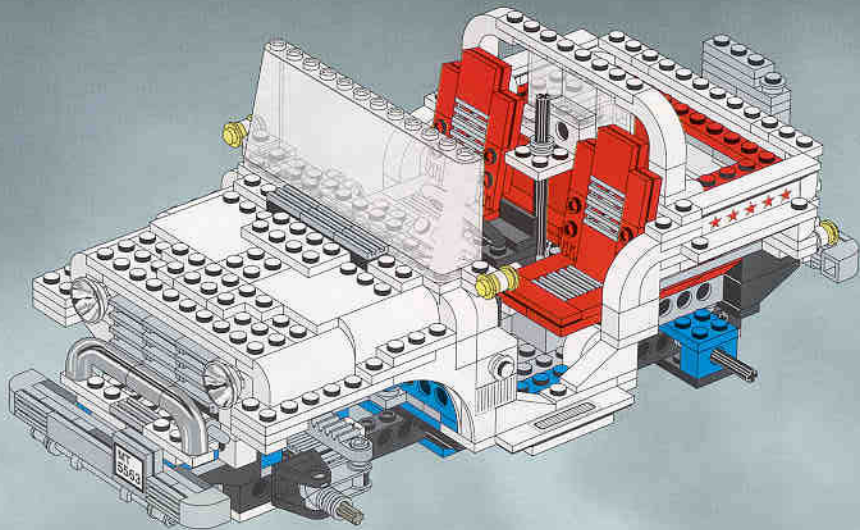

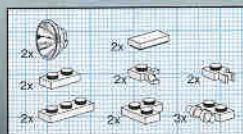

43

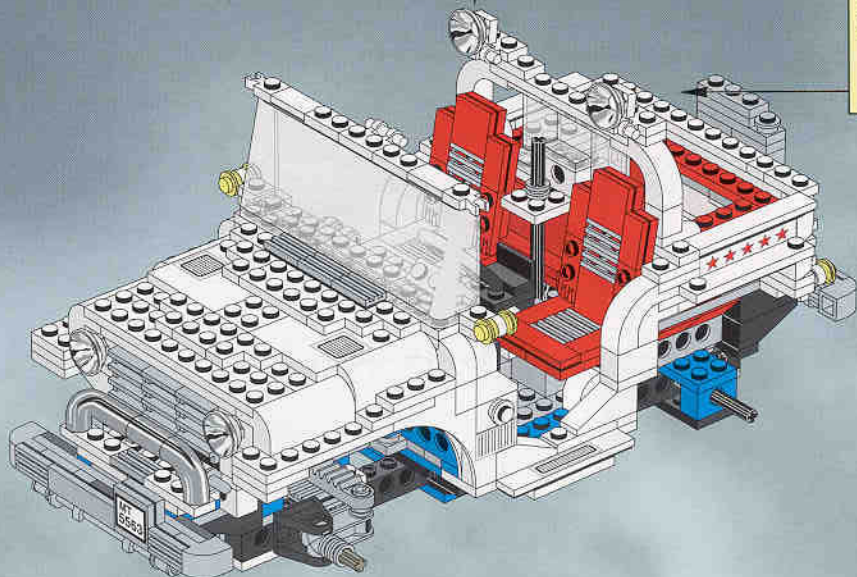
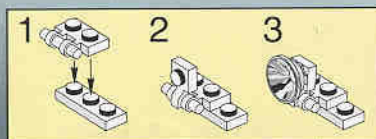

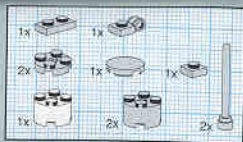

44

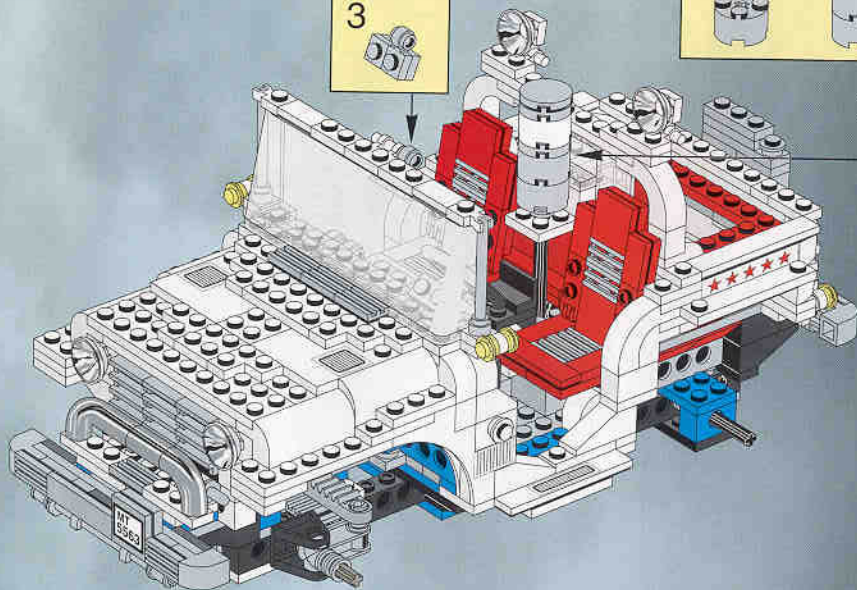
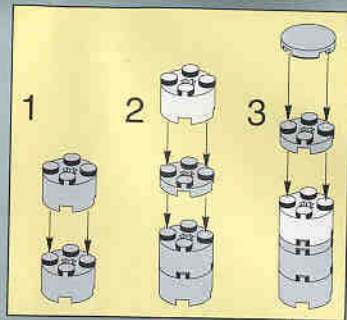
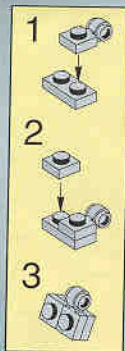

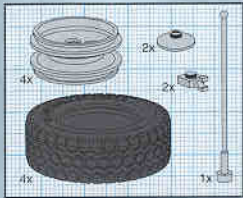

45

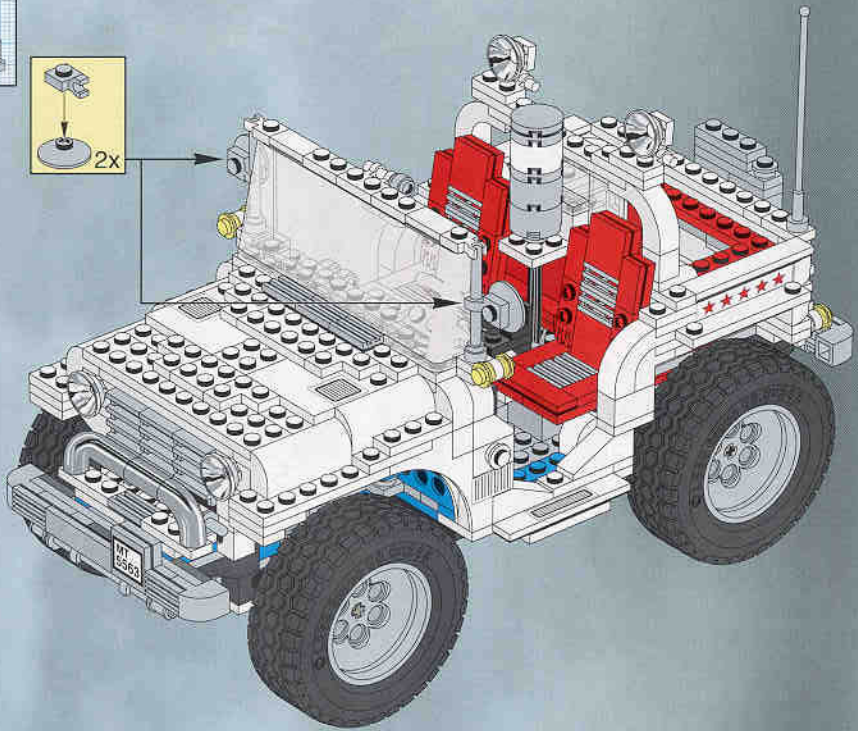
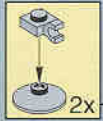

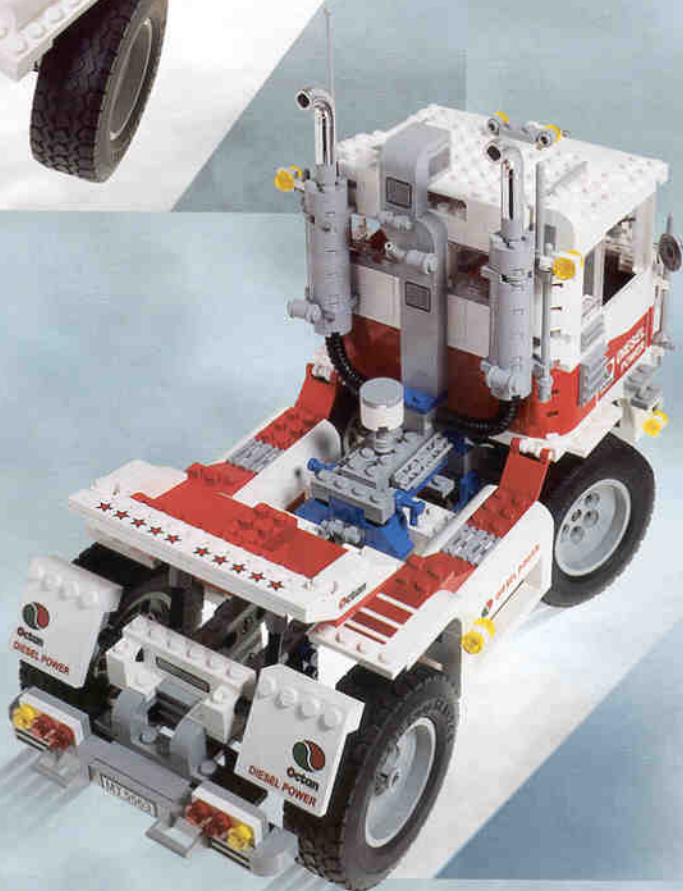

1



2



DIESEL POWER 

 DIESEL POWER

DIESEL
POWER



DIESEL
POWER

 DIESEL
POWER 

 **Octan**

MT
5563

MT
5563



Octan

Octan



Octan

DIESEL POWER



Octan

DIESEL POWER

